



SERVICE MANUAL

COMPACT COMPONENT SYSTEM

MX-J550R MX-J552R

These are models with RDS function that is added to the preceding model, the MX-J500. Therefore the SERVICE MANUAL for this model is consisting of Instructions, Block diagrams, Standard schematic diagrams, Printed circuit boards and Parts list only. For others, please refer to the SERVICE MANUAL for MX-J500/MX-J506(No.20804).

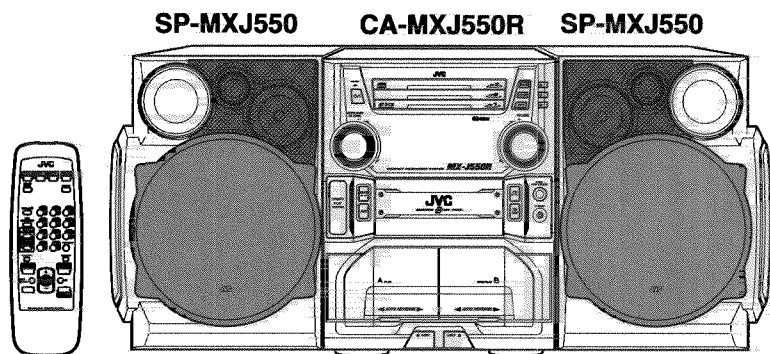

This illustration is MX-J550R

Area Suffix	
B	U.K.
E	Continental Europe
EN	Northern Europe
EV	Eastern Europe



Each difference point

Model	CD/DECK/RECEIVER	SPEAKER	Color		
			Tray fitting	Panel	Net
MX-J550R(B/E/EN/EV)	CA-MXJ550R	SP-MXJ550	Silver	Silver & blue	Light blue
MX-J550R(E/EN)	CA-MXJ550R	SP-MXJ550			
MX-J552R(E/EN)	CA-MXJ552R	SP-MXJ552R	Titan	Dark gray	Blue

Contents

Safety precautions	1-2	Instructions (SP-MXJ550/SP-MXJ552R)	1-14~15
Important for laser products	1-3	Block diagrams	2-1
Preventing static electricity	1-4	Standard schematic diagrams	2-3
Precautions at disassembly		Printed circuit boards	2-10~14
and parts replacement	1-5	Parts list	3-1~27
Instructions (CA-MXJ550R/CA-MXJ552R)	1-6~13		

Safety Precautions

1. This design of this product contains special hardware and many circuits and components specially for safety purposes. For continued protection, no changes should be made to the original design unless authorized in writing by the manufacturer. Replacement parts must be identical to those used in the original circuits. Services should be performed by qualified personnel only.
2. Alterations of the design or circuitry of the product should not be made. Any design alterations of the product should not be made. Any design alterations or additions will void the manufacturer's warranty and will further relieve the manufacture of responsibility for personal injury or property damage resulting therefrom.
3. Many electrical and mechanical parts in the products have special safety-related characteristics. These characteristics are often not evident from visual inspection nor can the protection afforded by them necessarily be obtained by using replacement components rated for higher voltage, wattage, etc. Replacement parts which have these special safety characteristics are identified in the Parts List of Service Manual. Electrical components having such features are identified by shading on the schematics and by (Δ) on the Parts List in the Service Manual. The use of a substitute replacement which does not have the same safety characteristics as the recommended replacement parts shown in the Parts List of Service Manual may create shock, fire, or other hazards.
4. The leads in the products are routed and dressed with ties, clamps, tubings, barriers and the like to be separated from live parts, high temperature parts, moving parts and/or sharp edges for the prevention of electric shock and fire hazard. When service is required, the original lead routing and dress should be observed, and it should be confirmed that they have been returned to normal, after re-assembling.
5. Leakage current check (Electrical shock hazard testing)

After re-assembling the product, always perform an isolation check on the exposed metal parts of the product (antenna terminals, knobs, metal cabinet, screw heads, headphone jack, control shafts, etc.) to be sure the product is safe to operate without danger of electrical shock.

Do not use a line isolation transformer during this check.

- Plug the AC line cord directly into the AC outlet. Using a "Leakage Current Tester", measure the leakage current from each exposed metal parts of the cabinet, particularly any exposed metal part having a return path to the chassis, to a known good earth ground. Any leakage current must not exceed 0.5mA AC (r.m.s.)

- Alternate check method

Plug the AC line cord directly into the AC outlet. Use an AC voltmeter having 1,000 ohms per volt or more sensitivity in the following manner. Connect a 1,500 Ω 10W resistor paralleled by a 0.15 μ F AC-type capacitor between an exposed metal part and a known good earth ground.

Measure the AC voltage across the resistor with the AC voltmeter.

Move the resistor connection to each exposed metal part, particularly any exposed metal part having a return path to the chassis, and measure the AC voltage across the resistor. Now, reverse the plug in the AC outlet and repeat each measurement. Voltage measured any must not exceed 0.75 V AC (r.m.s.). This corresponds to 0.5 mA AC (r.m.s.).

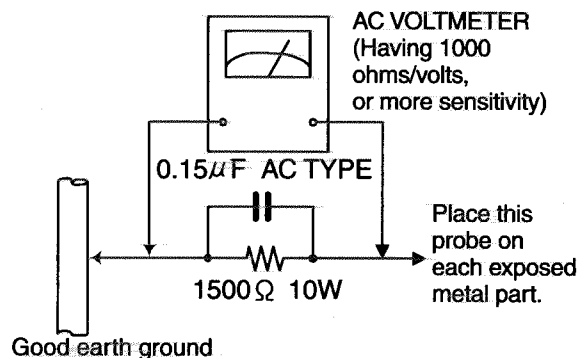

Warning

1. This equipment has been designed and manufactured to meet international safety standards.
2. It is the legal responsibility of the repairer to ensure that these safety standards are maintained.
3. Repairs must be made in accordance with the relevant safety standards.
4. It is essential that safety critical components are replaced by approved parts.
5. If mains voltage selector is provided, check setting for local voltage.

⚠ CAUTION Burrs formed during molding may be left over on some parts of the chassis. Therefore, pay attention to such burrs in the case of performing repair of this system.

Important for laser products

1. CLASS 1 LASER PRODUCT

2. DANGER : Invisible laser radiation when open and interlock failed or defeated. Avoid direct exposure to beam.

3. CAUTION : There are no serviceable parts inside the Laser Unit. Do not disassemble the Laser Unit. Replace the complete Laser Unit if it malfunctions.

4. CAUTION : The compact disc player uses invisible laser radiation and is equipped with safety switches which prevent emission of radiation when the drawer is open and the safety interlocks have failed or are defeated. It is dangerous to defeat the safety switches.

5. CAUTION : If safety switches malfunction, the laser is able to function.

6. CAUTION : Use of controls, adjustments or performance of procedures other than those specified herein may result in hazardous radiation exposure.

⚠ CAUTION Please use enough caution not to see the beam directly or touch it in case of an adjustment or operation check.

WARNING : Osynlig laserstrålning är denna del är öppnad och spårren är urkopplad. Betrakta ej strålen.

VARO : Avattaessa ja suojalukitus ohitettaessa olet alltiina näkymättömälle lasersäteilylle. Älä katso säteeseen.

ADVARSEL : Usynlig laserstrålning ved åbning , når sikkerhedsafbrydere er ude af funktion. Undgå udsættelse for stråling.

ADVARSEL : Usynlig laserstrålning ved åpning, når sikkerhetsbryteren er avslott. unngå utsettelse for stråling.

REPRODUCTION AND POSITION OF LABELS

WARNING LABEL

DANGER : Invisible laser radiation when open and interlock or defeated. AVOID DIRECT EXPOSURE TO BEAM. (e)	VARO : Avattaessa ja suojalukitus ohitettaessa olet alltiina näkymättömälle lasersäteilylle. Älä katso säteeseen. (d)	WARNING : Osynlig laserstrålning är denna del är öppnad och spårren är urkopplad. Betrakta ej strålen. (s)	ADVARSEL : Usynlig laserstrålning ved åbning , når sikkerhedsafbrydere er ude af funktion. Undgå udsættelse for stråling. (f)
---	---	--	---

**CLASS 1
LASER PRODUCT**

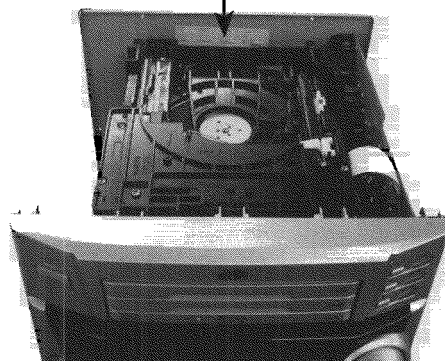
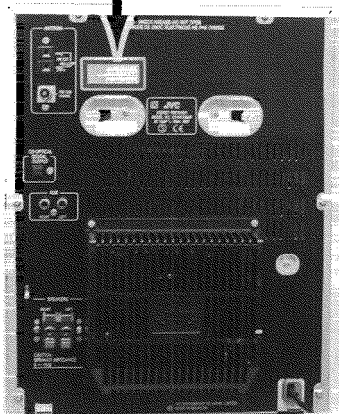

Preventing static electricity

1. Grounding to prevent damage by static electricity

Electrostatic discharge (ESD), which occurs when static electricity stored in the body, fabric, etc. is discharged, can destroy the laser diode in the traverse unit (optical pickup). Take care to prevent this when performing repairs.

2. About the earth processing for the destruction prevention by static electricity

In the equipment which uses optical pick-up (laser diode), optical pick-up is destroyed by the static electricity of the work environment.

Be careful to use proper grounding in the area where repairs are being performed...

2-1 Ground the workbench

Ground the workbench by laying conductive material (such as a conductive sheet) or an iron plate over it before placing the traverse unit (optical pickup) on it.

2-2 Ground yourself

Use an anti-static wrist strap to release any static electricity built up in your body.

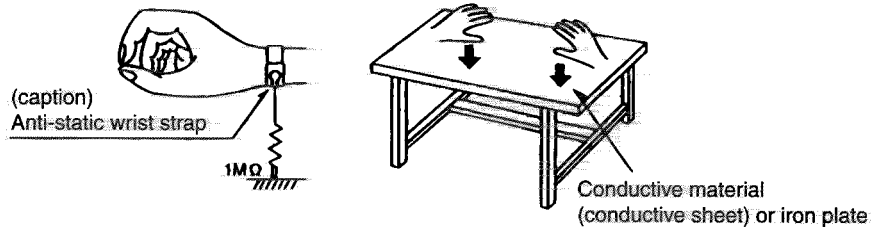

3. Handling the optical pickup

1. In order to maintain quality during transport and before installation, both sides of the laser diode on the replacement optical pickup are shorted. After replacement, return the shorted parts to their original condition. (Refer to the text.)
2. Do not use a tester to check the condition of the laser diode in the optical pickup. The tester's internal power source can easily destroy the laser diode.

4. Handling the traverse unit (optical pickup)

1. Do not subject the traverse unit (optical pickup) to strong shocks, as it is a sensitive, complex unit.
2. Cut off the shorted part of the flexible cable using nippers, etc. after replacing the optical pickup. For specific details, refer to the replacement procedure in the text. Remove the anti-static pin when replacing the traverse unit. Be careful not to take too long a time when attaching it to the connector.
3. Handle the flexible cable carefully as it may break when subjected to strong force.
4. It is not possible to adjust the semi-fixed resistor that adjusts the laser power. Do not turn it

Attention when traverse unit is decomposed

***Please refer to "Disassembly method" in the text for pick-up and how to detach the CD traverse mechanism.**

1. Remove the disk stopper and T. bracket on the CD changer mechanism assembly.
2. Disconnect the harness from connector on the CD motor board.
2. CD traverse unit is put up as shown in Fig.1.
3. Solder is put up before the card wire is removed from connector CN601 on the CD servo control board as shown in Fig. 2.
(When the wire is removed without putting up solder, the CD pick-up assembly might destroy.)
4. Please solder after connecting the card wire with CN601 when you install picking up in the substrate.

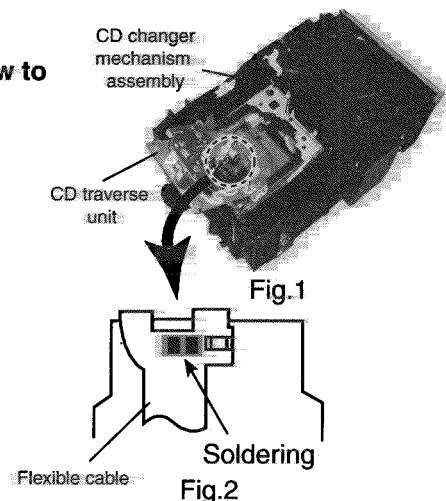

Precautions at disassembling and parts replacement

This model is charged with electricity on the power board even if the power cord is unplugged. Therefore, always discharge electricity in accordance with the steps given below before starting disassembling of the unit and/or replacement of parts.

1. While referring to the disassembling steps, remove the metal cover and the CD changer mechanism.
2. Set electrical resistances of 1k Ω , 1/4W to the places between the + and - terminals of the respective condensers C204 and C205 on the power board, and discharge electricity for 4 ~ 5 seconds.

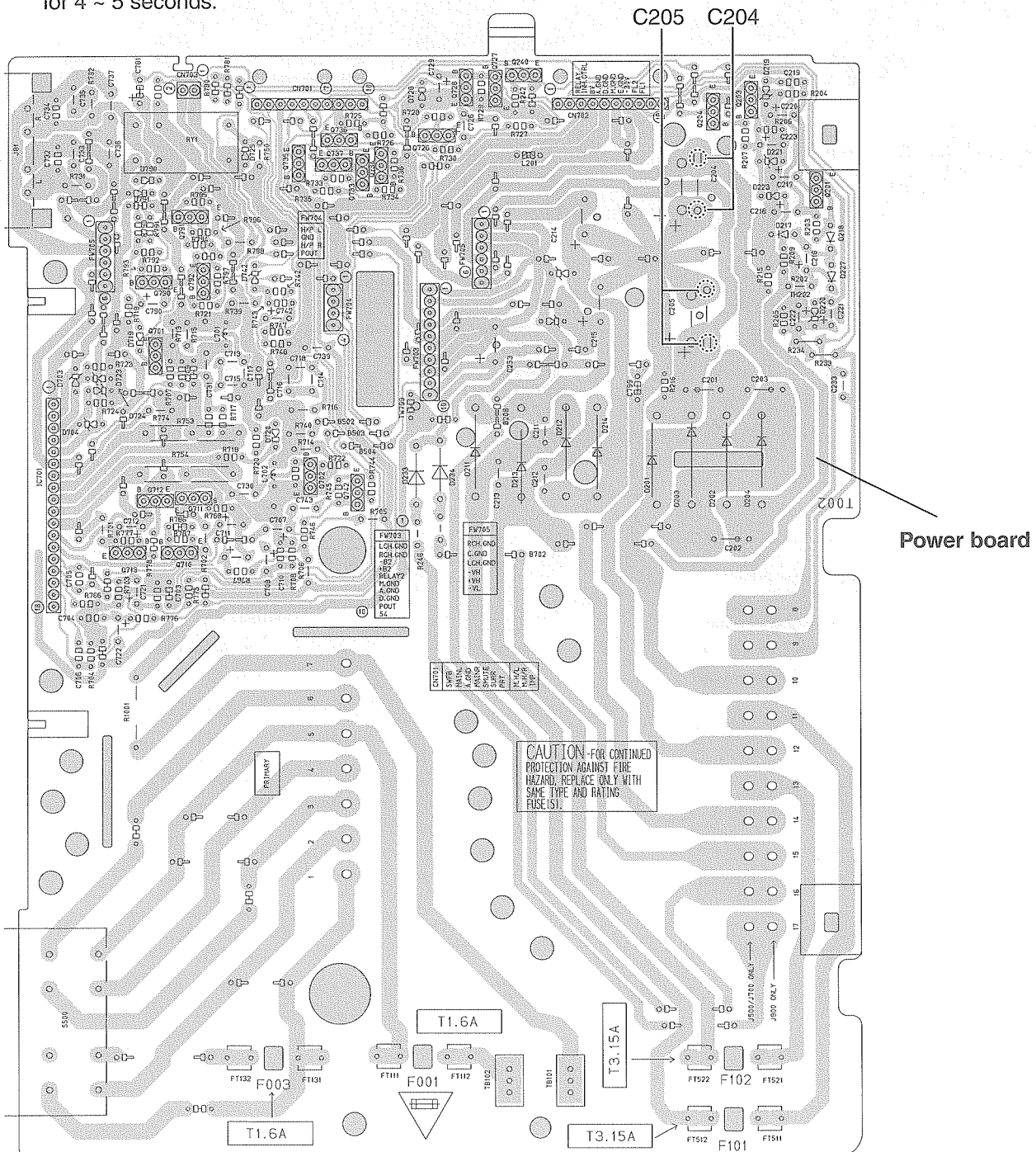

MX-J550R
MX-J552R

Instructions (CA-MXJ550R/CA-MXJ552R)

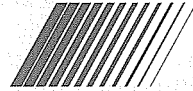

COMPACT COMPONENT SYSTEM

CA-MXJ750R/CA-MXJ552R CA-MXJ550R/CA-MXJ500

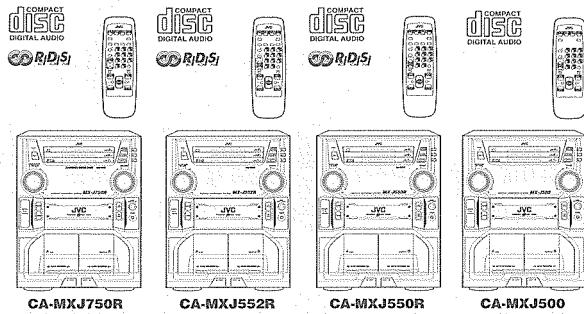

INSTRUCTIONS

For Customer Use:
Enter below the Model No. and Serial No. which are located either on the rear, bottom or side of the cabinet. Retain this information for future reference.

Model No. _____
Serial No. _____

GV70029-00BA
[B]

Warnings, Cautions and Others

IMPORTANT for the U.K.
DO NOT cut off the mains plug from this equipment. If the plug fitted is not suitable for the power points in your home or the cable is too short to reach a power point, then obtain an appropriate safety approved extension lead or consult your dealer.
BE SURE to replace the fuse only with an identical approved type, as originally fitted.
If earthed the mains plug is cut off ensure to remove the fuse and dispose of this plug immediately, to avoid a possible shock hazard by inadvertent connection to the mains supply.
If this product is not supplied fitted with a mains plug then follow the instructions given below.

IMPORTANT:
DO NOT make any connection to the terminal which is marked with the letter E or by the safety earth symbol or coloured green or green-and-yellow.
The wires in the mains lead on this product are coloured in accordance with the following code:
Blue : Neutral
Brown : Live
As these colours may not correspond with the coloured markings identifying the terminals in your plug proceed as follows:
The wire which is coloured blue must be connected to the terminal which is marked with the letter N or coloured blue.
The wire which is coloured brown must be connected to the terminal which is marked with the letter L or coloured red.
IF IN DOUBT - CONSULT A COMPETENT ELECTRICIAN.

IMPORTANT FOR LASER PRODUCTS
REPRODUCTION OF LABELS

① CLASSIFICATION LABEL, PLACED ON REAR ENCLOSURE

**CLASS 1
LASER
PRODUCT**

② WARNING LABEL, PLACED INSIDE THE UNIT

ENGR: Visible laser radiation when eyes are exposed to direct or reflected beam.	VERBODEN: Proef niet aan het licht te komen of te kijken. Gebruik niet als een spel.	CAUTION: Visible laser radiation when eyes are exposed to direct or reflected beam. Do not use as a toy.	AVOID: Avoidance of eye exposure to direct or reflected beam. Do not use as a toy.
ENGR: Visible laser radiation when eyes are exposed to direct or reflected beam.	VERBODEN: Proef niet aan het licht te komen of te kijken. Gebruik niet als een spel.	CAUTION: Visible laser radiation when eyes are exposed to direct or reflected beam. Do not use as a toy.	AVOID: Avoidance of eye exposure to direct or reflected beam. Do not use as a toy.

1. CLASS 1 LASER PRODUCT
2. DANGER: Invisible laser radiation when open and interlock failed or dislodged. Avoid direct exposure to beam.
3. CAUTION: Do not open the top cover. There are no user serviceable parts inside the Unit, leave all servicing to qualified service personnel.

Caution - (U) switch
Disconnect the mains plug to shut the power off completely. The (U) switch in any position does not disconnect the mains line. The power can be remote controlled.

CAUTION
To reduce the risk of electrical shocks, fire, etc.:
1. Do not remove screws, covers or cabinet.
2. Do not expose this appliance to rain or moisture.

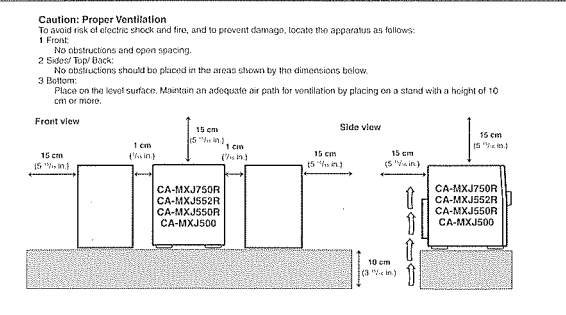

SAFETY INSTRUCTIONS "SOME DOS AND DON'TS ON THE SAFE USE OF EQUIPMENT"

This equipment has been designed and manufactured to meet international safety standards but, like any electrical equipment, care must be taken if you are to obtain the best results and safety is to be assured.

- Do read the operating instructions before you attempt to use the equipment.
 - Do ensure that all electrical connections (including the mains plug, extension leads and interconnections between pieces of equipment) are properly made and in accordance with the manufacturer's instructions. Switch off and withdraw the mains plug when making or changing connections.
 - Do consult your dealer if you are ever in doubt about the installation, operation or safety of your equipment.
 - Do be careful with glass panels or doors on equipment.
 - DON'T continue to operate the equipment if you are in any doubt about it working normally, or if it is damaged in any way—switch off, withdraw the mains plug and consult your dealer.
 - DON'T remove any fixed cover as this may expose dangerous voltages.
 - DON'T leave equipment switched on when it is unattended unless it is specifically stated that it is designed for unattended operation or has a standby mode. Switch off using the switch on the equipment and make sure that your family know how to do this.
 - Special arrangements may need to be made for infirm or handicapped people.
 - DON'T use equipment such as personal stereos or radios so that you are distracted from the requirements of traffic safety. It is illegal to watch television whilst driving.
 - DON'T listen to headphones at high volume as such use can permanently damage your hearing.
 - DON'T obstruct the ventilation of the equipment, for example with curtains or soft furnishings.
 - Overheating will cause damage and shorten the life of the equipment.
 - DON'T use makeshift stands and NEVER fix legs with wood screws — to ensure complete safety always fit the manufacturer's approved stand or legs with the fittings provided according to the instructions.
 - DON'T allow electrical equipment to be exposed to rain or moisture.
- ABOVE ALL**
- NEVER let anyone, especially children, push anything into holes, slots or any other opening in the case (this could result in a fatal electrical shock);
 - NEVER guess or take chances with electrical equipment of any kind — it is better to be safe than sorry!

Introduction

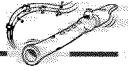

We would like to thank you for purchasing one of our JVC products. Before operating this unit, read this manual carefully and thoroughly to obtain the best possible performance from your unit, and retain this manual for future reference.

About This Manual

This manual is organized as follows:

- The manual mainly explains operations using the buttons and controls on the unit. You can also use the buttons on the remote control if they have the same or similar names (or marks) as those on the unit. If operation using the remote control is different from that using the unit, it is then explained.
- Basic and common information that is the same for many functions is grouped in one place, and is not repeated in each procedure. For instance, we do not repeat the information about turning on/off the unit, setting the volume, changing the sound effects, and others, which are explained in the section "Common Operations" on pages 9 to 11.
- The following marks are used in this manual:



Gives you warnings and cautions to prevent damage or risk of fire/electric shocks. Also gives you information which is not good for obtaining the best possible performance from the unit.



Gives you information and hints you had better know.

Precautions

Installation

- Install in a place which is level, dry and neither too hot nor too cold—between 5°C (41°F) and 35°C (95°F).
- Install the unit in a location with adequate ventilation to prevent internal heat build-up in the unit.
- Leave sufficient distance between the unit and the TV.
- Keep the speakers away from the TV to avoid interference with TV.



DO NOT install the unit in a location near heat sources, or in a place subject to direct sunlight, excessive dust or vibration.

Power sources

- When unplugging from the wall outlet, always pull the plug, not the AC power cord.



DO NOT handle the AC power cord with wet hands.

Moisture condensation

Moisture may condense on the lens inside the unit in the following cases:

- After starting heating in the room.
- In a damp room.
- If the unit is brought directly from a cold to a warm place. Should this occur, the unit may malfunction. In this case, leave the unit turned on for a few hours until the moisture evaporates, unplug the AC power cord, and then plug it in again.

Others

- Should any metallic object or liquid fall into the unit, unplug the unit and consult your dealer before operating any further.
- If you are not going to operate the unit for an extended period of time, unplug the AC power cord from the wall outlet.



DO NOT disassemble the unit since there are no user serviceable parts inside.

- If anything goes wrong, unplug the AC power cord and consult your dealer.

- 1 -

Contents

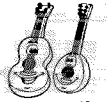

Location of the Buttons and Controls	3	Playing Back Tapes	18
Front Panel	3	Playing Back a Tape	18
Remote Control	5	Locating the Beginning of a Song—Music Scan	18
Getting Started	6	Recording	19
Unpacking the Batteries into the Remote Control	6	Recording a Tape on Deck B	19
Connecting Antennas	6	Dubbing Tapes	20
Connecting Speakers	7	CD Direct Recording	20
Connecting Other Equipment	8	Auto Edit Recording	21
Common Operations	9	Using the Timers	22
Tuning On or Off the Power	9	Using Daily Timer	22
Setting the Clock	9	Using Recording Timer	23
Selecting the Sources	9	Using Sleep Timer	24
Adjusting the Volume	10	Timer Priority	24
Reinforcing the Bass Sound	10	Maintenance	25
Selecting the Sound Modes	10	Troubleshooting	26
Creating Your Own Sound Mode—Manual Mode	11	Additional Information	27
Listening to FM and AM (LW/MW) Broadcasts	12	Specifications	28
Tuning in a Station	12		
Presetting Stations	12		
Tuning in a Preset Station	12		
Receiving FM Stations with RDS	13		
Changing the RDS Information	13		
Searching for Programs by PTY Codes (PTY Search)	13		
Switching to a Program Type of Your Choice/Temporarily	14		
Playing Back CDs	15		
Loading CDs	15		
Playing Back the Entire Discs—Continuous Play	15		
Basic CD Operations	15		
Programming the Playing Order of the Tracks—Program Play	16		
Playing at Random—Random Play	17		
Repeating Tracks or CDs—Repeat Play	17		
Prohibiting Disc Ejection—Tray Lock	17		

- 2 -

Location of the Buttons and Controls

Become familiar with the buttons and controls on your unit.

Front Panel

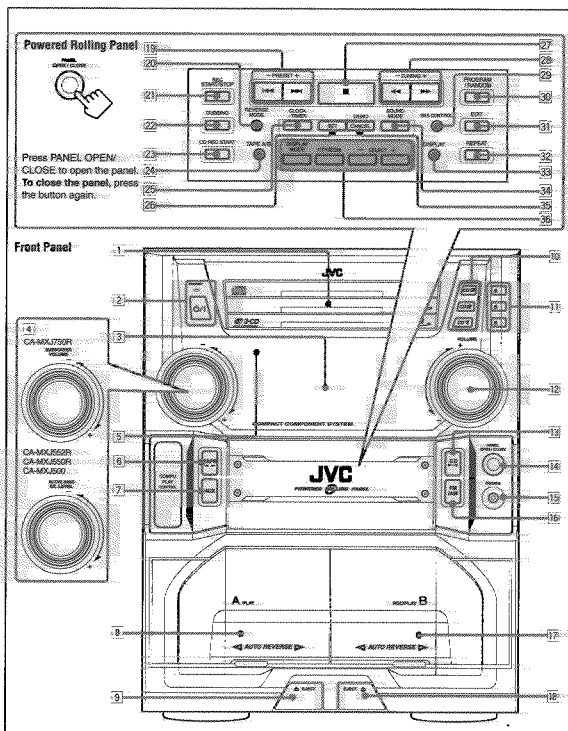

- 3 -

Continued

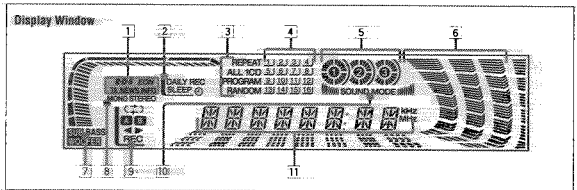

See pages in the parentheses for details.

Front Panel

- Disc trays
- OP (On/Standby) button and STANDBY lamp (9)
- Display window
- For CA-MXJ750R: SUBWOOFER VOLUME control (10) For CA-MXJ552R/CA-MXJ550R/CA-MXJ500: ACTIVE BASS EX. (extension) LEVEL control (10)
- Remote sensor
- TAPE button and lamp (9, 18) Pressing this button also turns on the unit.
- AUX button and lamp (9) Pressing this button also turns on the unit.
- Deck A cassette holder (18)
- EJECT button for deck A (18) Pressing one of these buttons also turns on the unit.
- (CD tray open/close) buttons (15) Pressing one of these buttons also turns on the unit.
- VOLUME control (10)
- CD button (play/pause button and lamp (9, 15)) Pressing this button also turns on the unit.
- PANEL OPEN/CLOSE button (9) Pressing this button also turns on the unit.
- PHONES jack (10)
- FM/AM button and lamp (9, 12)
- Deck B cassette holder (18, 19)
- EJECT button for deck B (18, 19)
- SET button (9, 12, 22–24)
- (stop) button (15–21)
- TUNING +/- buttons (11, 16, 18)
- SEA CONTROL button (11)
- PROGRAM/RANDOM button (16, 17, 20)
- EDIT button (21)
- REPEAT button (17)
- DISPLAY button (9)
- SOUND MODE button (10)
- CANCEL button (9, 17, 22)
- DEMO button (8)
- For CA-MXJ750R/CA-MXJ552R/CA-MXJ550R ONLY: RDS operation buttons (13) DISPLAY MODE, PTY/EON, and SELECT +/- buttons

Display window

- For CA-MXJ750R/CA-MXJ552R/CA-MXJ550R ONLY: RDS operation indicators: RDS, EON, and TA/NEWS/INFO indicators
- Timer indicators: DAILY (Daily Timer), REC (Recording Timer), SLEEP, and @ (Timer) indicators
- CD play mode indicators: REPEAT (ALL/CD/1), PROGRAM, and RANDOM indicators
- CD track number indicators
- Disc indicators: MONO and STEREO indicators
- SEA (Sound Effect Amplifier) pattern indicator
- For CA-MXJ750R: SUBWOOFER indicator (10) For CA-MXJ552R/CA-MXJ550R/CA-MXJ500: BASS indicator (10)
- Timer operation indicators: MONO and STEREO indicators
- Tape operation indicators: C (reverse mode), A/B (operating deck), (tape direction), and REC (recording) indicators
- SOUND MODE indicator
- Main display: Shows the source name, frequency, etc.

- 4 -



Remote Control

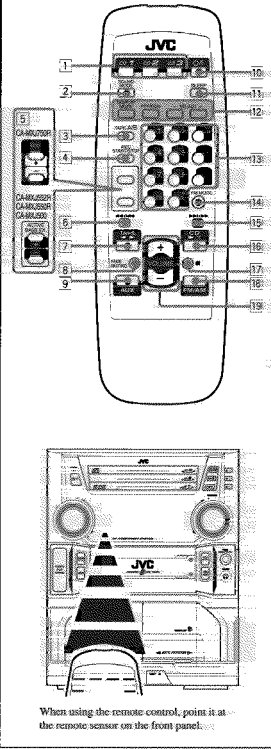

Remote Control

- 1 Disc number buttons (CD1, CD2, and CD3) (15)
 - Pressing one of these buttons also turns on the unit.
- 2 SOUND MODE button (10)
- 3 TAPE A/B button (18)
- 4 REC START/STOP button (19; 21)
- 5 For CA-MXJ550R: SUBWOOFER +/- buttons (10)
 - For CA-MXJ552R/CA-MXJ550R/CA-MXJ500: ACTIVE BASS EX. (extension) +/- buttons (10)
- 6 <←/→> (fast left/reverse search) button (16-18)
 - TAPE <←/→> button (9; 18)
 - Pressing this button also turns on the unit.
- 7 FADE MUTING button (10)
- 8 AUX button (9)
 - Pressing this button also turns on the unit.
- 9 OFF (On/Standby) button (9)
- 10 SLEEP button (24)
- 11 For CA-MXJ550R/CA-MXJ552R/CA-MXJ550R ONLY: RDS operation buttons (13)
 - DISPLAY MODE, PTY/EON, and SELECT +/- buttons
- 12 Number buttons (12; 16)
- 13 FM MODE button (12)
- 14 <→> (forward search/fast right) button (16-18)
- 15 CD <→> button (9; 15)
- 16 CD <→> button (9; 15)
 - Pressing this button also turns on the unit.
- 17 <|> (stop) button (15-21)
- 18 FM/AM button (9; 12)
 - Pressing this button also turns on the unit.
- 19 VOLUME +/- buttons (10)

When using the remote control, point it at the remote sensor on the front panel.

Getting Started

Unpacking

After unpacking, check to be sure that you have all the following items:

- AM (LW/MW) loop antenna (1)
- FM antenna (1)
- Remote control (1)
- Batteries (2)

If any is missing, consult your dealer immediately.

Putting the Batteries into the Remote Control

Insert the batteries — R6(SUM-3)/AA(15F) — into the remote control, by matching the polarity (+ and -) on the batteries with the + and - markings on the battery compartment.

When the remote control can no longer operate the unit, replace both batteries at the same time.

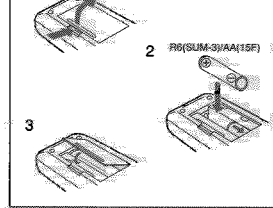

- DO NOT use an old battery together with a new one.
- DO NOT use different types of batteries together.
- DO NOT expose batteries to heat or flame.
- DO NOT leave the batteries in the battery compartment when you are not going to use the remote control for an extended period of time. Otherwise, it will be damaged from battery leakage.

Connecting Antennas

FM antenna

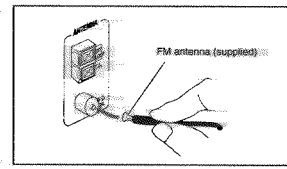

- 1 Attach the FM antenna to the FM 75 Ohm COAXIAL terminal.
- 2 Extend the FM antenna.
- 3 Fasten it up in the position which gives you the best reception, then fix it on the wall, etc.

About the supplied FM antenna: The FM antenna supplied with this unit can be used as temporary measure. If reception is poor, you can connect an outdoor FM antenna.

To connect an outdoor FM antenna: Before connecting it, disconnect the supplied FM antenna.

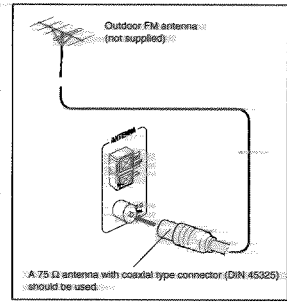

AM (LW/MW) antenna

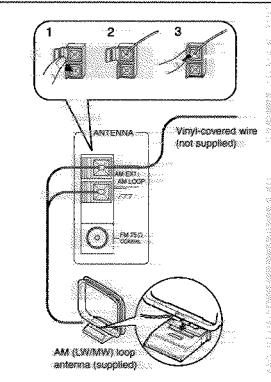

- 1 Connect the AM (LW/MW) loop antenna to the AM LOOP terminals as illustrated.
- 2 Turn the AM (LW/MW) loop antenna until you have the best reception.

To connect an outdoor AM (LW/MW) antenna: When reception is poor, connect a single vinyl-covered wire to the AM EXT terminal and extend it horizontally. (The AM (LW/MW) loop antenna must remain connected.)

- For better reception of both FM and AM (LW/MW):
 - Make sure the antenna conductors do not touch any other terminals and connecting cords.
 - Keep the antennas away from metallic parts of the unit, connecting cords, and the AC power cord.

Connecting Speakers

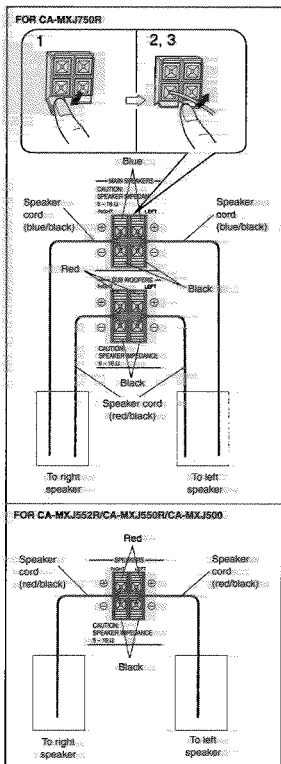

- 1 Press and hold the clamp of the speaker terminal on the rear of the unit.
- 2 Insert the end of the speaker cord into the terminal. Match the polarity (color) of the speaker terminals: ⊕ to ⊕ and ⊖ to ⊖.
- 3 Release the finger from the clamp.

IMPORTANT: Use only speakers with the same speaker impedance as indicated by the speaker terminals on the rear of the unit.

Connecting Other Equipment

You can connect both analog and digital equipment.

- DO NOT connect any equipment while the power is on.
- DO NOT plug in any equipment until all connections are complete.

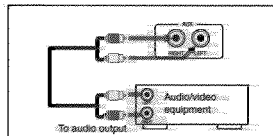

For playing the other equipment through this unit: connect between the audio output jacks on the other equipment and AUX jacks by using audio cords (not supplied).

To connect audio equipment with an optical digital input terminal: You can record CD sound onto the connected digital equipment.

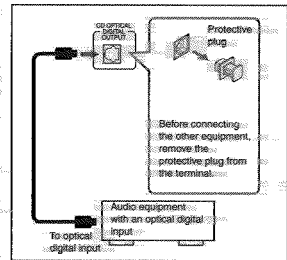

Connect an optical digital cord (not supplied) between the optical digital input terminal on the other equipment and the CD OPTICAL DIGITAL OUTPUT terminal.

NOW, you can plug in the unit and other connected equipment FINALLY!

When connecting the AC power cord into a wall outlet, the unit automatically starts display demonstration.

To stop the display demonstration, press any button on the unit or on the remote control.

To start the display demonstration manually: Press and hold DEMO for more than 2 seconds.

To stop the demonstration, press any button.

Common Operations

Turning On or Off the Power

To turn on the unit, press **Q/1** so that the **STANDBY** lamp goes off.

The Powered Rolling Panel opens automatically.

To turn off the unit (on standby), press **Q/1** again so that the **STANDBY** lamp lights up.

The Powered Rolling Panel also closes.

A little power is always consumed even while the unit is on standby.

To switch off the power supply completely, unplug the AC power cord from the AC outlet.

Notes When you unplug the AC power cord or if a power failure occurs, the clock is reset to "00:00" right away, while the timer preset stations (see page 12) will be erased in a few days.

Setting the Clock

Before operating the unit any further, first set the clock built-in in this unit.

On the unit ONLY:

1 Press PANEL OPEN/CLOSE.

The unit is turned on and the Powered Rolling Panel opens automatically.

2 Press CLOCK/TIMER.

The hour digits start flashing on the display.

3 Press **←/4** or **→/3** to adjust the hour, then press SET.

If you want to correct the hour after pressing SET, press CANCEL. The hour digits start flashing again.

4 Press **←/4** or **→/3** to adjust the minute, then press SET.

To check the clock time

Press DISPLAY while playing any source. Each time you press the button, the source indication and the clock time alternate on the display.

To adjust the clock again

If you have adjusted the clock before, you need to press CLOCK/TIMER repeatedly until the clock setting mode is selected.

Each time you press the button, the clock/timer setting modes change as follows:

DAILY → ON TIME → REC
Canceled → Clock setting (The four digits start flashing)

If there is a power failure, the clock loses the settings and is reset to "00:00". You need to set the clock again.

Selecting the Sources

To listen to the FM/AM (LW/MW) broadcasts, press FM/AM. (See page 12.)

To play back CDs, press CD **▶/11**. (See pages 15-17.)

To play back tapes, press TAPE **▶/12**. (See page 18.)

To select the external equipment as the source, press AUX/CONTROL.

When you press the play button for a particular source (FM/AM, CD **▶/11**, AUX, and TAPE **▶/12**), the unit turns on, and the Powered Rolling Panel opens automatically (and the unit starts playing the source if it is ready). COMPU PLAY CONTROL.

Adjusting the Volume

You can adjust the volume level only while the unit is turned on.

Turn the VOLUME control clockwise to increase the volume or counterclockwise to decrease it.

The volume level can be adjusted in 32 steps (MIN. VOL. 1 → VOL. 30, and MAX.).

When using the remote control, press VOLUME **+** to increase the volume or press VOLUME **-** to decrease it.

For private listening, connect a pair of headphones to the PHONES jack. No sound comes out of the speakers. Be sure to turn down the volume before connecting or putting on headphones.

DO NOT turn off (on standby) the unit with the volume set to an extremely high level; otherwise, a sudden blast of sound can damage your hearing, speakers and/or headphones when you turn on the unit or start playing any source next time. REMEMBER you cannot adjust the volume level while the unit is on standby.

When using the remote control, press SUBWOOFER **+** to increase the subwoofer volume or press SUBWOOFER **-** to decrease it.

For CA-MXJ552R/CA-MXJ550R/CA-MXJ500, the ACTIVE BASS EX. (extension) LEVEL control provided for this unit can maintain the richness and fullness of the bass sound while listening to any source at low volume.

Turn the ACTIVE BASS EX. LEVEL control clockwise to increase the bass sound or counterclockwise to decrease it. The bass sound level can be adjusted in 4 steps (BASS 1 → BASS 3, and MAX.).

BASS indicator always lights up when the unit is on.

When using the remote control, press ACTIVE BASS EX. **+** to increase the bass sound level or press ACTIVE BASS EX. **-** to decrease it.

To cancel the Active Bass Extension, turn the control counterclockwise until "BASS OFF" appears.

To turn down the volume level temporarily

Press FADE MUTING on the remote control. The volume level gradually decreases to "MIN". To restore the sound, press the button again.

Reinforcing the Bass Sound

This function only affects the playback sound, but does not affect your recording.

For CA-MXJ750R

The SUBWOOFER VOLUME control provided for this unit can enhance the subwoofer sound if subwoofers are connected to the rear of this unit (see page 7).

Turn the SUBWOOFER VOLUME control clockwise to increase the subwoofer sound or counterclockwise to decrease it.

The subwoofer level can be adjusted in 6 steps (WOOFER 1 → WOOFER 5, and MAX.).

SUBWOOFER indicator always lights up when the unit is on.

Selecting the Sound Modes

You can select one of the 6 preset sound modes (3 surround modes and 3 SEA → Sound Effect Amplifier → modes). This function only affects the playback sound, but does not affect your recording.

To select the sound modes, press SOUND MODE until the sound mode you want appears on the display. The SOUND MODE indicator also lights up on the display.

Each time you press the button, the sound modes change as follows:

D CLUB → HALL → STADIUM → ROCK → POP → CLASSIC → MANUAL 3 → MANUAL 2 → MANUAL 1 → OFF (Canceled)

Listening to FM and AM (LW/MW) Broadcasts

Tuning in a Station

1 Press FM/AM.

The unit automatically turns on and tunes in the previously tuned station (either FM or AM → LW/MW). The Powered Rolling Panel automatically opens.

2 Start searching for stations.

On the unit: Press and hold TUNING **+/+** for more than 1 second.

On the remote control: Press and hold **+/+** for more than 1 second.

The unit starts searching for stations and stops when a station of sufficient signal strength is tuned in. If a program is broadcast in stereo, the STEREO indicator lights up.

To stop during searching, press TUNING **+/+** (or **+/+** briefly and repeatedly). The frequency changes step by step.

To change the FM reception mode

When an FM stereo broadcast is hard to receive or noisy, press FM MODE on the remote control so that the MONO indicator lights up on the display. Reception improves.

To restore the stereo effect, press FM MODE again so that the MONO indicator goes off. In this stereo mode, you can hear stereo sounds when a program is broadcast in stereo.

Presetting Stations

You can preset 30 FM and 15 AM (LW/MW) stations. In some cases, test frequencies have been already memorized for the user since the factory examined the tuner preset function before shipment. This is not a malfunction. You can preset the stations you want into memory by following the presetting method.

There is a time limit in doing the following steps. If the setting is canceled before you finish, start from step 1 again.

On the unit ONLY:

1 Tune in the station you want to preset. See "Tuning in a Station."

FM 87.50

2 Press SET.

3 Press PRESET **+/+** to select a preset number.

4 Press SET again.

The tuned station in step 1 is stored in the preset number selected in step 3.

Storing a new station on a used number erases the previously stored one.

When you unplug the AC power cord or if a power failure occurs, the preset stations will be erased in a few days. If this happens, preset the stations again.

Tuning in a Preset Station

1 Press FM/AM.

The unit automatically turns on and tunes in the previously tuned station (either FM or AM → LW/MW). The Powered Rolling Panel automatically opens.

Each time you press the button, the band alternates between FM and AM (LW/MW).

2 Select a preset number:

On the unit: Press PRESET **+/+**.

On the remote control: Press the number buttons.

For preset number 5, press 5.

For preset number 15, press +10 then 5.

For preset number 20, press +10, then 10.

For preset number 25, press +10, +10, then 5.

For preset number 30, press +10, +10, then 10.

Surround modes *

D. CLUB: Increases resonance and bass.

HALL: Adds depth and brilliance to the sound.

STADIUM: Adds clarity and spreads the sound, like in an outdoor stadium.

SEA (Sound Effect Amplifier) modes:

ROCK: Boosts low and high frequency. Good for acoustic music.

POP: Good for vocal music.

CLASSIC: Good for classical music.

Manual modes:

MANUAL 1/2/3: Your individual mode stored in memory. See "Creating Your Own Sound Mode → Manual Mode."

OFF: Cancels the sound mode.

* Surround elements are added in the SEA elements to create a being-there feeling in your room.

When one of these modes is selected, the SOUND MODE indicator lights up as **SOUND MODE**.

While one of the SEA modes including manual modes (SEA) elements without surround elements is selected, it lights up as **SOUND MODE**.

Creating Your Own Sound Mode — Manual Mode

You can change SEA pattern to suit your preference. These changed settings can be stored in the MANUAL 1, 2, and 3 modes.

There is a time limit in doing the following steps. If the setting is canceled before you finish, start from step 1 again.

If you want to add the surround elements in your SEA pattern, select one of the surround modes (D. CLUB, HALL, or STADIUM) before starting the procedure below.

On the unit ONLY:

1 Press and hold SEA CONTROL until "SEA CONT" appears on the display.

LOW 10

Current level appears.

2 Adjust the SEA pattern.

1 Press **←/4** or **→/3** to select the frequency range to adjust (LOW, MID, HIGH).

2 Press **←/4** or **→/3** to adjust the level (-3 to +3) of the selected frequency range.

3 Repeat steps 1) and 2) to adjust the level of the other frequency ranges.

3 Press SEA CONTROL again.

MANUAL

4 Press **←/4** or **→/3** to select one of the MANUAL 1, 2, and 3 modes into which you want to store the SEA pattern.

5 Press SEA CONTROL again.

MEMOR

The SOUND MODE indicator also lights up. The SEA pattern you have created are stored into the MANUAL mode selected in the above step.

To use your own sound mode: Select MANUAL 1, 2, or 3 mode when using the sound modes. See "Selecting the Sound Modes."



Receiving FM Stations with RDS

This section is for the model having RDS functions that is CA-MXJ750R, CA-MXJ552R, and CA-MXJ550R.

RDS allows FM stations to send an additional signal along with their regular program signals. For example, the stations send their station names, as well as information about what type of program they broadcast, such as sports or music, etc.

When tuned to an FM station which provides the RDS service, the RDS indicator lights up on the display.

With the unit, you can receive the following types of RDS signals:

PS (Program Service):

Shows commonly known station names.

PTY (Program Type):

Shows types of broadcast programs.

RT (Radio Text):

Shows text messages the station sends.

EON (Enhanced Other Networks):

Provides the information about the types of the programs sent by other RDS stations.

More about RDS:

- Some FM stations and AM (LW/MW) stations do not provide RDS signals.
- RDS services vary among FM RDS stations. For details on RDS services in your area, check with local radio stations.
- RDS may not work correctly if the received station is not transmitting the signals properly or if the signal strength is weak.

Changing the RDS Information

You can see RDS information on the display while listening to an FM station.

Press DISPLAY MODE.

- Each time you press the button, the display changes to show the following information:

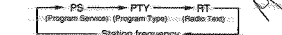

If no PS, PT, or RT signals are sent by a station, "NO PS", "NO PT", or "NO RT" appears in the main display.

If the unit takes time to show the RDS information received from a station, "WAIT PS", "WAIT PT", or "WAIT RT" may appear on the display.

Searching for Programs by PTY Codes (PTY Search)

One of the advantages of RDS is that you can locate a particular kind of program by specifying the PTY codes.

- For details on the PTY codes, see "Additional Information" on page 27.

To search for a program using the PTY codes, REMEMBER you must preset FM RDS stations to use the EON function. If not yet done, see page 12.

There is a time limit in doing the following steps. If the setting is canceled before you finish, start from step 1 again.

1 Press PTY/EON until "PTY" and "SELECT" alternately appears on the display.

- Each time you press the button, RDS operation mode changes as follows:

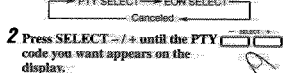

- Each time you press the button, the PTY codes change as follows:



3 Press PTY/EON once again.

- While searching, "SEARCH" and the selected PTY code alternate on the display.
- The unit searches 30 preset FM stations, stops when it finds the one you have selected ("FOUND" appears), and tunes in that station.
- If no program is found, "NOT" and "FOUND" alternately appears on the display and the unit returns to the last received station.

To stop searching any time during the process, Press PTY/EON while searching.

Switching to a Program Type of Your Choice Temporarily

By receiving EON data sent by FM RDS stations, the EON function allows the unit to switch temporarily to a broadcast program of your choice (TA, NEWS, and INFO) from a different station.

- The EON function only works when you are listening to preset FM RDS stations providing EON data.
- The EON indicator lights while receiving a station with EON data.

To activate the EON function, REMEMBER you must preset FM RDS stations to use the EON function. If not yet done, see page 12.

There is a time limit in doing the following steps. If the setting is canceled before you finish, start from step 1 again.

1 Press PTY/EON until "EON" and "SELECT" alternately appear on the display.

- Each time you press the button, RDS operation mode changes as follows:

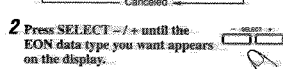

2 Press SELECT +/- until the EON data type you want appears on the display.

- The selected EON data type indicator also flashes.

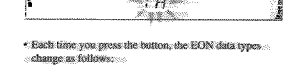

- TA: Traffic announcements.
- NEWS: News.
- INFO: Program the purpose of which is to impart advice in the widest sense.
- OFF: The EON function is canceled. The EON data type indicator (TA, NEWS, INFO) goes off.

Now, the EON function is activated. See "How the EON function actually works."

3 Press PTY/EON once again.

- The EON data type indicator stops flashing and remains lit.

Now, the EON function is activated. See "How the EON function actually works."

How the EON function actually works:

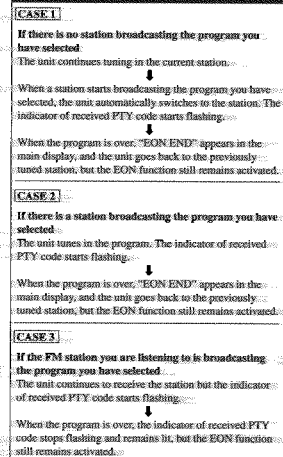

More about the EON function:

- EON data sent from some stations may not be compatible with the unit. In this case, the EON function may not work correctly.
- While listening to a program tuned in by the EON function, the station does not change even if another network station starts broadcasting a program of the same EON data.
- The EON function is canceled when you change the source to CD, TAPE, or AUX, while it is temporarily canceled when you change the source to AM.

Playing Back CDs

Loading CDs

On the unit ONLY:

- Press ▲ for the disc tray (CD1 to 3) you want to load a CD onto. The unit automatically turns on and the disc tray comes out. The Powered Rolling Panel also opens automatically.

- Place a disc correctly on the circle of the disc tray, with its label side up.



- When using a CD single (8 cm), place it on the inner circle of the disc tray.

- Press the same ▲ you have pressed in step 1. The disc tray closes, and the corresponding disc indicator (CD1 to CD3) lights up on the display.

- Repeat steps 1 to 3 to place other CDs.

When loading more than one CD continuously. When you press ▲ for the next tray you want to place another CD onto, the first disc tray automatically closes and then the next tray comes out.

About the disc indicators. Each disc indicator corresponds to the disc tray of the same number.



- The disc marker lights up for the disc number you have selected.
- The disc indicator flashes while the corresponding CD is being played.
- The disc indicator goes off when the unit has detected that there is no CD on the corresponding disc tray.

Playing Back the Entire Discs — Continuous Play

You can play CDs continuously.

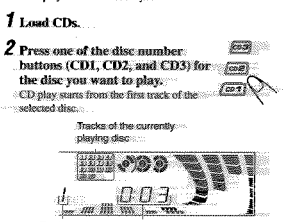

- Pressing CD ►/M instead of the disc number buttons starts playing back if a CD is on the trays.
- To stop during play, press ■.
- To remove the disc, press ▲ for the corresponding disc tray.

CD playback sequence: When 3 CDs are loaded on the disc trays, they are played in one of the following sequences:

- When CD1 is pressed: CD1 → CD2 → CD3 (then stops)
- When CD2 is pressed: CD2 → CD3 → CD1 (then stops)
- When CD3 is pressed: CD3 → CD1 → CD2 (then stops)
- When only 2 CDs are loaded, they are played in the same order, but the disc tray without a CD is skipped.

Basic CD Operations

While playing a CD, you can do the following operations:

- To exchange CDs during playback of another CD ►/M corresponding to a CD, not playing or selected currently, to eject and exchange the CD.
- If you exchange CDs during play, the current play will not stop until all CDs you have exchanged are played.

- To stop play for a moment: Press CD ►/M. While pausing, the elapsed playing time flashes on the display.
- To resume play, press CD ►/M again.

To locate a particular point in a track during play, press and hold ◀ or ▶.

- ◀: Fast reverses the disc.
- ▶: Fast forwards the disc.

When using the remote control, press and hold ◀ or ▶.

To go to another track: Press ◀ or ▶ repeatedly before or during playback.

- ◀: Goes back to the beginning of the current or previous tracks.
- ▶: Skips to the beginning of the next or succeeding tracks.

When using the remote control, press ◀ or ▶ before playing. You can change the tracks continuously.

- To go to another track directly using the number buttons: Pressing the number button(s) before or during play allows you to start playing the track number you want.
- Ex.: For track number 5, press 5.
- For track number 15, press +10, then 5.
- For track number 20, press +10, then 10.
- For track number 32, press +10, +10, +10, then 2.

Programming the Playing Order of the Tracks

Program Play: You can arrange the order in which the tracks play before you start playing. You can program up to 32 tracks.

- To use Repeat play (see page 17) for Program play, press REPEAT after starting Program play.

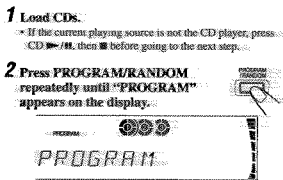

- If a program has been stored in memory, the program is recalled up.

Each time you press the button, CD play mode changes as follows:

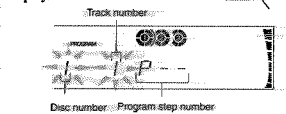
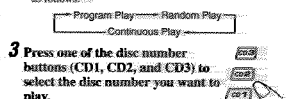

- Select a track from the CD selected in the above step. On the unit: Press ◀ or ▶ to select the track number, then press SET.



On the remote control: Press the number buttons. For how to use the number buttons, see "To go to another track directly using the number buttons" described to the left.

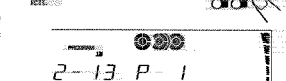

- Program other tracks you want. To program tracks from the same disc, repeat step 4 and 4.
- Press CD ►/M. The tracks are played in the order you have programmed.

To stop during play, press ■. To exit from Program play mode, press PROGRAM/RANDOM repeatedly again before or after play so that the unit enters another play mode. (The program you have made is stored in memory until you turn off the unit or erase the programs.)



To check the program contents
Before playing, you can check the program contents by pressing ◀◀/▶▶ or ▶▶/▶▶ on the remote control.
▶▶/▶▶: Shows the programmed tracks in the programmed order.
◀◀/▶▶: Shows them in the reverse order.

To modify the program
Before playing, you can erase the programmed tracks shown on the display by pressing CANCEL.
▶▶/▶▶: Each time you press the button, the programmed track shown on the display is erased from the program.

To add tracks in the program before play, simply select the track numbers you want to add by following step 4 of the programming procedure on page 16.
To erase the entire program before or after play, press ■. "PROGRAM" appears on the display.
Ejecting a CD will also erase the track numbers programmed from the ejected CD.

If you try to program a 33rd track
"FULL" will appear on the display.

If your entry is ignored
You have tried to program a track from an empty tray, or a track number that does not exist on the CD (for example, selecting track 14 on a CD that only has 12 tracks). Such entries are ignored.

Playing at Random — Random Play

The tracks of all loaded CDs will play at random.
To use Repeat play for Random play, press REPEAT after starting Random play.

1 Load CDs.
If the current playing source is not the CD player, press CD ▶/▶, then ■ before going to the next step.

2 Press PROGRAM/RANDOM repeatedly until "RANDOM" appears on the display.

Each time you press the button, CD play mode changes as follows:
Program Play — Random Play

3 Press CD ▶/▶.
The tracks are played at random.
Random play ends when all the tracks are played once.

To skip the currently playing track, press ▶▶ (or ▶▶/▶▶ on the remote control).

To stop during play, press ■.
Random play also stops when one of the disc trays is opened.

To exit from Random play mode, press PROGRAM/RANDOM repeatedly again before or after play so that the unit enters another play mode.

Notes
Even if you press ▶▶ (or ▶▶/▶▶ on the remote control), you cannot go back to the previous tracks during Random play.

Repeating Tracks or CDs — Repeat Play

You can have all the CDs, the program or the individual track currently playing repeat as many times as you like.

To repeat play, press REPEAT during or before playing. To use Repeat play for Program play and Random play, press the button after starting playback.
Each time you press the button, Repeat play mode changes as follows, and the following indicator lights up on the display:

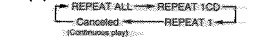

REPEAT ALL: Repeats all the tracks on all the CDs (continuously or at random), or all the tracks in the program.

REPEAT 1CD: Repeats all the tracks on one CD.

REPEAT 1: Repeats one track on one CD.

REPEAT 1CD is not used for Program play and Random play.

To cancel Repeat play, press REPEAT repeatedly until the REPEAT indicator (REPEAT ALL, REPEAT 1CD, or REPEAT 1) goes off from the display.

Prohibiting Disc Ejection — Tray Lock
You can prohibit CD ejection from the unit and can lock CDs.

This operation is possible only using the buttons on the unit.
To prohibit disc ejection, press ▲ for any disc tray while holding ■. (If there is any disc tray opened, close it first.) "LOCKED" appears for a while, and the loaded CDs are locked.

To cancel the prohibition and unlock the CDs, press ▲ for any disc tray while holding ■.
"UNLOCKED" appears for a while, and the loaded CDs are unlocked.

If you try to eject CDs
"LOCKED" appears to inform you that the Tray Lock is in use.

Playing Back Tapes



You can play back type I, type II, and type IV tapes without changing any settings.

Playing Back a Tape

1 Press EJECT (▲) for the deck you want to use.



2 Put a cassette in, with the exposed part of the tape down.



3 Close the cassette holder gently.

If you put cassettes in both decks A and B, the last deck you have put a cassette into is selected.

To operate the other deck, press TAPE A/B.

4 Press TAPE ▶▶.

The tape play starts and the tape direction indicator (▶▶) starts flashing slowly to indicate the tape running direction.

Each time you press the button, the tape direction changes.
▶▶ plays the front side.
◀▶ plays the reverse side.

When the tape plays to the end, the deck automatically stops if the Reverse Mode is not on. (See "To play both sides repeatedly — Reverse Mode.")

To stop during play, press ■.
To operate the other deck, press TAPE A/B, then TAPE ▶▶.

To fast wind to the left or to the right, press ◀◀/▶▶ (◀◀/▶▶ or ▶▶/▶▶ on the remote control) while the tape is not running.
The tape direction indicator (▶▶) starts flashing quickly on the display.

To remove the cassette, press ▲ EJECT for deck A or EJECT ▲ for deck B.

To play both sides repeatedly — Reverse Mode

Reverse Mode works for both decks at the same time. When it is in use, the tape automatically reverses at the end of a side and the unit starts playing the other side of the tape, and repeats the same process.

To use Reverse Mode, press REVERSE MODE so that the Reverse Mode indicator on the display lights up like (◀▶).

To cancel Reverse Mode, press the button again so that the Reverse Mode indicator on the display lights up like (▶▶).

Notes
When Reverse Mode is on with cassettes in both decks A and B, after the reverse (◀▶) side of the tape finishes playing, the tape in the other deck starts playing.

Locating the Beginning of a Song — Music Scan

You can use Music Scan to locate the beginning of a song. Music Scan searches for blank portions that usually separate recorded songs, then plays the next song.

To find the beginning of the current song
During play, press ◀◀/▶▶ (◀◀/▶▶ or ▶▶/▶▶ on the remote control) in the opposite direction to the tape play.

The tape direction indicator of the opposite direction to the tape play starts flashing slowly.

Searching stops automatically at the beginning of the current song, and the current song starts automatically.

To find the beginning of the next song
During play, press ▶▶/▶▶ (▶▶/▶▶ or ▶▶/▶▶ on the remote control) in the same direction as the tape play. The tape direction indicator of the same direction as the tape play starts flashing slowly and quickly alternately.

Searching stops automatically at the beginning of the next song, and the next song starts automatically.

Music Scan works by detecting a 4-second long blank between each song, so it will not work well in the following cases:
• No blank at the beginning of a song.
• Noise (often caused by much use or poor quality dubbing) which fills the blank.
• Long, very soft passages or pauses in a song.

Notes
The use of the C-120 or thinner tape is not recommended, since characteristic deterioration may occur and this tape easily jams in the pinch rollers and the capstans.

Recording

IMPORTANT:

It should be noted that it may be unlawful to re-record pre-recorded tapes, records, or discs without the consent of the owner of copyright in the sound or video recording, broadcast or cable programme and in any literary, dramatic, musical, or artistic embodied therein.

The recording level is automatically set correctly, so it is not affected by the VOLUME control and the SUBWOOFER VOLUME control for CA-MXJ750R, ACTIVE BASS EX. LEVEL control for CA-MXJ552R, CA-MXJ50R, and CA-MXJ50B. Thus, during recording, you can adjust the sound you are actually listening to without affecting the recording level.
While recording, you can hear sound modes through the speakers or headphones. However, the sound is recorded without these effects (see page 10).
If recordings you have made have excessive noise or static, the unit may be too close to a TV. Increase the distance between the TV and the unit.
You can use type I and II tapes for recording.

To protect your recording

Cassettes have two small tabs on the back to protect against unexpected erasure or re-recording.
To protect your recording, remove these tabs.
To re-record on a protected tape, cover the holes with adhesive tape.
When using type II tapes, be careful not to cover the holes used to detect the tape type.

To keep the best recording and playback sound quality

If the heads, capstans, and pinch rollers of the cassette decks become dirty, the following will occur:
• Impaired sound quality
• Discontinuous sound
• Fading
• Incomplete erasure
• Difficulty in recording

To clean the heads, capstans, and pinch rollers
Use a cotton swab moistened with alcohol.

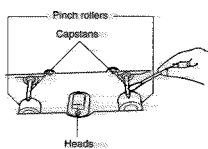

To demagnetize the heads
Turn off the unit, and use a head demagnetizer (available at electronics and record shops).

Recording a Tape on Deck B

1 Press EJECT ▲ for the deck B.

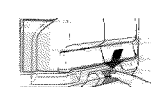

2 Put in a recordable cassette, with the exposed part of the tape down.

3 Close the cassette holder gently.

4 Check the tape direction of deck B.

If the tape direction is not correct, press TAPE ▶▶ (twice) then ■ to change the tape direction.

5 Start playing the source — FM, AM (LW/MW)*, CD player, deck A, or auxiliary equipment connected to AUX jacks.

When the source is CD, you can also use CD Direct Recording (see page 20) and Auto Edit Recording (see page 21).
When the source is deck A, you can also use the dubbing method. (See "Dubbing Tapes" on page 20).
* See "To record an AM (LW/MW) station — Beat Cut" on page 20.

6 Start recording.

On the unit:
Press REC START/STOP.
On the remote control:
Press and hold REC START/STOP for more than 1 second.
The REC (recording) indicator lights up on the display and recording starts.

To stop during recording, press REC START/STOP again or ■.
To remove the cassette, press EJECT ▲ for deck B.

To record on both sides — Reverse Mode
Press REVERSE MODE so that the Reverse Mode indicator lights up as (◀▶).

When using the Reverse Mode for recording, start recording in the forward (▶▶) direction first. Otherwise, recording will stop when recording is done only on one side (reverse) of the tape.

To cancel Reverse Mode, press the button again so that the Reverse Mode indicator lights up as (▶▶).

To record an AM (LW/MW) station — Beat Cut

While recording an AM (LW/MW) broadcast, beats may be heard (which are never heard when listening to the broadcast without recording it).

If this occurs, press PROGRAM/RANDOM repeatedly while recording, until the beats are reduced.

Each time you press the button, the display changes to show the following:
CUT1 → CUT2 → CUT3 → CUT4

Dubbing Tapes
It is preferable that the tape type (type I or II) you record from be the same as the tape type you record onto when dubbing tapes.

1 Press TAPE ▶▶, then ■.



2 Put the source cassette in deck A, and a recordable cassette into deck B.
Put the cassettes in both decks so that the tapes will run in the forward (▶▶) direction.

3 Press DUBBING.
Dubbing starts.

To stop during dubbing, press ■.

To record on both sides — Reverse Mode
Press REVERSE MODE so that the Reverse Mode indicator lights up as (◀▶).

To cancel Reverse Mode, press the button again so that the Reverse Mode indicator lights up as (▶▶).

CD Direct Recording

Everything on the CD goes onto the tape in the order it is on the CD, or according to the order you have made for Program play.

1 Put a recordable cassette into deck B.

2 Place a disc correctly on the circle of the disc tray, with its label side up.

3 Press one of the disc number buttons (CD1 to CD3) to select the disc, then ■.

4 Press CD REC START.
"CD REC" appears, and the REC (recording) indicator lights up on the display.
Deck B starts recording and the CD player starts playing.

When the recording is done, "CD REC FINISHED" appears on the display, and the CD player and deck B stop.

To stop during CD Direct Recording, press ■ or REC START/STOP.

To record on both sides — Reverse Mode
Press REVERSE MODE so that the Reverse Mode indicator lights up as (◀▶).

When using the Reverse Mode for CD Direct Recording, start recording in the forward (▶▶) direction first. When the tape reaches its end while recording a song in the forward direction (▶▶), the last song will be recorded at the beginning of the reverse side (◀▶).

If you start recording on the reverse side (◀▶), recording will stop when recording is done only on one side (reverse) of the tape.

To cancel Reverse Mode, press the button again so that the Reverse Mode indicator lights up as (▶▶).



Using the Timers

Continued

Auto Edit Recording

By using Auto Edit Recording, you can record the CD tracks to fit the tape. Auto Edit Recording makes a program by selecting the CD tracks in numerical order. However, to prevent the end of the last track on the front side from being cut off, the last track is selected so as to fit on the remaining tape length.

On the unit ONLY:

- Load CDs.**
 - If the current playing source is not the CD player, press **CD** or **FM**, then **▶** before going to the next step.
- Press **EDIT**.
- Press the disc number button (CD1 to CD3) for the disc you want to record from.

The optimum tape length for the disc appears.

To change the tape length manually.
If the tape length selected is not satisfactory, you can change the tape length by pressing **◀** or **▶**. You can select the tape length among the following: 40, 46, 50, 54, 60, 64, 70, 74, 80, 84, and 90.

4 Press SET.

Tracks to be recorded on the reverse side (SIDE-B) appear.

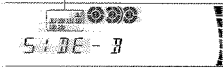

Each time you press the button, the tracks to be recorded on the front side (SIDE-A) and on the reverse side (SIDE-B) alternate.

5 Put a recordable cassette of appropriate length into deck B.

6 Press REVERSE MODE so that the Reverse Mode indicator lights up as (C).

Without turning on the Reverse Mode (C), recording will stop when the front side of the tape is recorded.

7 Press CD REC START.

The REC (recording) indicator lights up on the display. Deck B starts recording then, about 10 seconds later, the CD player starts playing. When the recording is done, "CD REC FINISHED" appears on the display, and the CD player and deck B stop.

- If a tape has not been rewound, deck B will rewind the tape before it starts recording.
- A 10-second blank portion is automatically created at the beginning of each side of the tape.

To stop during Auto Edit Recording.
Press **▶** or **STOP** to finish a 4-second blank portion is created on the recorded tape. (Remember a 4-second blank is important when using Music Scan—see page 18.)

To cancel Auto Edit Recording.
Press **CANCEL** before or after play. Pressing one of the following buttons will also cancel Auto Edit Recording: **▶**, **REC START/STOP**, and **PROGRAM/RANDOM**.

(There are three timers available—Recording Timer, Daily Timer, and Sleep Timer.)
Before using the timers, you need to set the clock built in the unit. (See page 9.)

Using Daily Timer

With Daily Timer, you can wake to your favorite music or radio program.

How Daily Timer actually works

The unit automatically turns on, sets the volume level to the preset level, and starts playing the specified source when the on-time comes (the **⊙** indicator flashes just before the on-time, and continues flashing while the timer is operating). Then, when the off-time comes ("OFF") flashes just before the off-time, the unit automatically turns off (stands by). The timer setting remains in memory until you change it. There is a time limit in doing the following steps. If the setting is canceled before you finish, start from step 1 again. If you have made a mistake while setting timer, press **CANCEL**. (However, this does not always work. If **CANCEL** does not work, press **CLOCK/TIMER** repeatedly and start from step 1 again.)

- Before you start...**
- When using a CD as the source to play, make sure there is a CD on the selected disc number tray.
 - When using a tape as the source to play, make sure that a tape is in the deck whose deck's indicator (A or B) is lit on the display.
 - Make sure that the tape direction is correct.
 - When using the external component as the source to play, set the timer equipped with the external component at the same time.

On the unit ONLY:

1 Press **CLOCK/TIMER** until "DAILY" appears on the display. The DAILY (Daily Timer) indicator also starts flashing on the display.



Each time you press the button, the timer setting modes change as follows:



(See page 9.)

2 Press CLOCK/TIMER again.

"ON TIME" appears for 2 seconds, then the unit enters on-time setting mode.



3 Set the on-time you want the unit to turn on.

- Press **◀** or **▶** to set the hour, then press **SET**.
- Press **◀** or **▶** to set the minute, then press **SET**. "OFF TIME" appears for 2 seconds, then the unit enters off-time setting mode.

4 Set the off-time you want the unit to turn off (on standby).

- Press **◀** or **▶** to set the hour, then press **SET**.
- Press **◀** or **▶** to set the minute, then press **SET**. The unit enters source selecting mode.



5 Press **◀** or **▶** to select the source to play, then press SET.

Each time you press **◀** or **▶**, the source changes as follows:

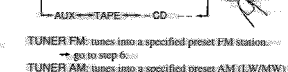

TUNER FM: tunes into a specified preset FM station. → go to step 6.
TUNER AM: tunes into a specified preset AM (LW/MW) station. → go to step 6.
CD: plays a disc from a specified track of a specified disc. → go to step 6.
TAPE: plays a tape in deck A or B. → go to step 7.
AUX: plays an external source. → go to step 7.

6 When selecting "CD" or "TUNER FM" or "TUNER AM"

- Press **◀** or **▶** to select the disc number, then press **SET**.
- Press **◀** or **▶** to set the track number, then press **SET**.

The unit enters volume setting mode.

7 Press **◀** or **▶** to set the volume level.

You can select the volume level from among the following: "VOL. 5", "VOL. 10", and "VOL. 15". If you select "VOL.", the volume is set to the last level when the unit has been turned off.



8 Press **SET** to complete the Daily Timer setting. The DAILY (Daily Timer) indicator stops flashing and remains lit. The settings you have done are shown on the display in sequence.

9 Press **OFF** to turn off the unit (on standby) if you have set the Daily Timer with the unit turned on.

To turn on or off Daily Timer after its setting is done

1 Press **CLOCK/TIMER** repeatedly until "DAILY" appears on the display.

2 To turn off the Daily Timer, press **CANCEL**. The DAILY (Daily Timer) indicator goes off from the display ("OFF" appears for a while). The Daily Timer is canceled, but the setting for the Daily Timer remains in memory.

To turn on the Daily Timer, press SET. The DAILY (Daily Timer) indicator lights up on the display. The settings you have done are shown on the display in sequence for your confirmation.

If the unit is turned on when the timer-on time comes, Daily Timer does not work.

Using Recording Timer

With Recording Timer, you can make a tape of a radio broadcast automatically.

How Recording Timer actually works

The unit automatically turns on, tunes into the specified station, sets the volume level to "MIN", and starts recording when the on-time comes (the **⊙** indicator flashes just before the on-time, and continues flashing while the timer is operating). Then, when the off-time comes ("OFF") appears just before the off-time, the unit automatically turns off (stands by). The timer setting remains in memory until you change it. There is a time limit in doing the following steps. If the setting is canceled before you finish, start from step 1 again. If you have made a mistake while setting the timer, press **CANCEL**. (However, this does not always work. If **CANCEL** does not work, press **CLOCK/TIMER** repeatedly and start from step 1 again.)

On the unit ONLY:

1 Put a recordable cassette into deck B.

2 Press **CLOCK/TIMER** until "REC" appears on the display. The REC (Recording Timer) indicator also starts flashing on the display.

Each time you press the button, the timer setting modes change as follows:



3 Press **CLOCK/TIMER** again. "ON TIME" appears for 2 seconds, then the unit enters on-time setting mode.



4 Set the on-time you want the unit to turn on.

- Press **◀** or **▶** to set the hour, then press **SET**.
- Press **◀** or **▶** to set the minute, then press **SET**. "OFF TIME" appears for 2 seconds, then the unit enters off-time setting mode.

The unit enters preset station selecting mode.

5 Set the off-time you want the unit to turn off (on standby).

- Press **◀** or **▶** to set the hour, then press **SET**.
- Press **◀** or **▶** to set the minute, then press **SET**. The unit enters preset station selecting mode.

6 Select the preset station.

- Press **◀** or **▶** to select the band (TUNER FM or TUNER AM), then press **SET**.
- Press **◀** or **▶** to select a preset channel number, then press **SET**. The REC (Recording Timer) indicator stops flashing and remains lit. The settings you have done are shown on the display in sequence.

7 Press **OFF** to turn off the unit (on standby) if necessary.

If you want to listen to another source while recording, Press **REC START/STOP** to stop recording. Without stopping it, you cannot change the source.

To turn on or off Recording Timer after its setting is done:

1 Press **CLOCK/TIMER** repeatedly until "REC" appears on the display.

2 To turn off the Recording Timer, press **CANCEL**. The REC (Recording Timer) indicator goes off from the display. The Recording Timer is canceled, but the setting for the Recording Timer remains in memory.

To turn on the Recording Timer, press SET. The REC (Recording Timer) indicator lights up on the display. The settings you have done are shown on the display in sequence for your confirmation.

Using Sleep Timer

With Sleep Timer, you can fall asleep to music. You can set Sleep Timer when the unit is turned on.

How Sleep Timer actually works

The unit automatically turns off after the specified time length passes.

On the remote control ONLY:

1 Press **SLEEP**. The time length until the shut-off time appears and the SLEEP indicator starts flashing on the display.

Each time you press the button, the time length changes as follows:

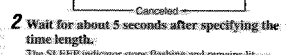

2 Wait for about 5 seconds after specifying the time length. The SLEEP indicator stops flashing and remains lit.

To check the remaining time until the shut-off time, press **SLEEP** once so that the remaining time until the shut-off time appears for about 5 seconds.

To change the shut-off time, press **SLEEP** repeatedly until the desired time length appears on the display.

To cancel the setting, press **SLEEP** repeatedly so that the SLEEP indicator goes off. Sleep Timer is also canceled when you turn off the unit.

Timer Priority

Since each timer can be set separately, you may wonder what happens if the setting for these timers overlaps. Here are examples:

Recording Timer has priority over Daily Timer and Sleep Timer.
If Daily Timer is set to come on while Recording Timer is operating, Daily Timer will not come on at all.

Recording Timer is set to come on while Sleep Timer is operating, Sleep Timer will not work (the SLEEP indicator does not go off).

Recording Timer is set to come on while Sleep Timer is operating, Sleep Timer will not work (the SLEEP indicator does not go off).

Maintenance



To get the best performance of the unit, keep your discs, tapes, and mechanism clean.

Handling discs



- Remove the disc from its case by holding it at the edge while pressing the center hole lightly.
- Do not touch the shiny surface of the disc, or bend the disc.
- Put the disc back in its case after use to prevent warping.



- Be careful not to scratch the surface of the disc when placing it back in its case.
- Avoid exposure to direct sunlight, temperature extremes, and moisture.



- To clean the disc:**
Wipe the disc with a soft cloth in a straight line from center to edge.

DO NOT use any solvent — such as conventional record cleaner, spray, thinner, or benzine — to clean the disc.

Handling cassette tapes



- If the tape is loose in its cassette, take up the slack by inserting a pencil in one of the reels and rotating.
- If the tape is loose, it may get stretched, cut, or caught in the cassette.



- Be careful not to touch the tapes' surfaces.



- Avoid the following places to store these tapes:
 - In dusty places
 - In direct sunlight or heat
 - In moist areas
 - Near a magnet

Troubleshooting



If you are having a problem with your unit, check this list for a possible solution before calling for service. If you cannot solve the problem from the hints given here, or the unit has been physically damaged, call a qualified person, such as your dealer, for service.

Symptom	Cause	Action
No sound is heard.	Connections are incorrect or loose.	Check all connections and make corrections. (See pages 6 to 8.)
Hard to listen to broadcasts because of noise.	Antennas are disconnected. The AM (LW/MW) loop antenna is too close to the unit. The FM antenna is not properly extended and positioned.	Reconnect the antennas correctly and securely. Change the position and direction of the AM (LW/MW) loop antenna. Extend the FM antenna at the best position.
The disc sound is discontinuous.	The disc is scratched or dirty.	Clean or replace the disc. (See page 25.)
The disc tray does not open or close.	The AC power cord is not plugged in. Trays are locked.	Plug the AC power cord. Unlock the trays. (See page 17.)
The disc does not play.	The disc is placed upside down.	Place the disc with the label side up.
The cassette tapes cannot be opened.	Power supply from the AC power cord has been cut off while the tape was running.	Turn on the unit.
Impossible to record.	Small tabs on the back of the cassette are removed.	Cover the holes with adhesive tape.
Operations are disabled.	The built-in microprocessor may be malfunctioning due to external electrical interference.	Unplug the AC power cord and then plug it back in.
Unable to operate the unit from the remote control.	The path between the remote control and the remote sensor on the unit is blocked. The batteries are exhausted.	Remove the obstruction. Replace the batteries.

- 25 -

Additional Information



This section is for the model having RDS functions — that is CA-MXJ750R, CA-MXJ552R, and CA-MXJ550R.

Description of the PTY codes:

NEWS: News.	FINANCE: Stock Market reports, commerce, trading, etc.
AFFAIRS: Topical program expanding or enlarging upon the news — debate, or analysis.	CHILDREN: Programs targeted at a young audience.
INFO: Program the purpose of which is to impart advice in the widest sense.	SOCIAL A.: Programs about sociology, history, geography, psychology and society.
SPOKE: Program concerned with any aspect of sports.	RELIGION: Religious programs.
EDUCATE: Educational programs.	TRAVEL: Travel information.
DRAMA: All radio plays and serials.	LEISURE: Programs about recreational activities.
CULTURE: Programs concerning any aspect of national or regional culture, including language, theatre, etc.	JAZZ: Jazz music.
SCIENCE: Programs about natural sciences and technology.	COUNTRY: Songs which originate from, or sustain the musical tradition of the American Southern States.
VARIETY: Used for mainly speech-based programs like quizzes, panel games and personality interviews.	NATIONAL: Current popular music of the nation or region in that country's language.
POP M: Commercial music of current popular appeal.	OLDIES: Music from the so-called "golden age" of popular music.
ROCK M: Rock music.	FOLK M: Music which has its roots in the musical culture of a particular nation.
M.O.R. M: Current contemporary music considered to be "easy listening".	DOCUMENT: Program concerning factual matters, presented in an investigative style.
LIGHT M: Instrumental music, and vocal or choral works.	TRAFFIC: Traffic announcements.
CLASSICS: Performances of major orchestral works, symphonies, chamber music, etc.	
OTHER M: Music not fitting into any of the other categories.	
WEATHER: Weather reports and forecasts.	

FINANCE: Stock Market reports, commerce, trading, etc.
CHILDREN: Programs targeted at a young audience.
SOCIAL A.: Programs about sociology, history, geography, psychology and society.
RELIGION: Religious programs.
TRAVEL: Travel information.
LEISURE: Programs about recreational activities.
JAZZ: Jazz music.
COUNTRY: Songs which originate from, or sustain the musical tradition of the American Southern States.
NATIONAL: Current popular music of the nation or region in that country's language.
OLDIES: Music from the so-called "golden age" of popular music.
FOLK M: Music which has its roots in the musical culture of a particular nation.
DOCUMENT: Program concerning factual matters, presented in an investigative style.
TRAFFIC: Traffic announcements.

Classification of the PTY codes for some FM stations may be different from the above list.

- 27 -

Specifications



CA-MXJ750R

Amplifier section
Output Power (IEC 268-3/DIN):
SUBWOOFERS: 65 W per channel, min. RMS, both channels driven into 6 Ω at 63 Hz with no more than 0.9% total harmonic distortion.
MAIN SPEAKERS: 20 W per channel, min. RMS, both channels driven into 6 Ω at 1 kHz with no more than 0.9% total harmonic distortion.
Audio input sensitivity/impedance:
at 1 kHz, measured at MAIN SPEAKERS:
AUX: 460 mV/50 kΩ
Digital output: CD OPTICAL DIGITAL OUTPUT:
Signal wave length: 660 nm
Output level: 15 dBm @ 12 dBm

Tuner
FM tuning range: 87.50 MHz ~ 108.00 MHz
AM tuning range: MW: 522 kHz ~ 1,629 kHz
LW: 144 kHz ~ 288 kHz

CD player
CD Capacity: 3 CDs
Dynamic range: 85 dB
Signal-to-noise ratio: 90 dB
Wow and flutter: immeasurable

Cassette deck
Frequency response:
Normal type I: 50 Hz ~ 14,000 Hz
CrO type II: 50 Hz ~ 14,000 Hz
Metal type IVE: 50 Hz ~ 14,000 Hz (only for playback)
Wow and flutter:
0.15% (WRMS)

General
Power requirement: AC 230 V/50 Hz
Power consumption: 120 W (at operation)
15 W (on standby)
Dimensions (approx.): 265 mm x 335 mm x 368 mm (W/H/D)
1076 mm x 1376 mm x 1478 mm
Mass (approx.): 9.9 kg (21.8 lbs)

Supplied accessories
See page 6.

Design and specifications are subject to change without notice.

CA-MXJ52R/CA-MXJ550R/CA-MXJ550

Amplifier section
Output Power (IEC 268-3/DIN):
73 W per channel, min. RMS, both channels driven into 6 Ω at 63 Hz with no more than 0.9% total harmonic distortion.
Audio input sensitivity/impedance (at 1 kHz):
AUX: 420 mV/50 kΩ
Digital output: CD OPTICAL DIGITAL OUTPUT:
Signal wave length: 660 nm
Output level: 15 dBm @ 12 dBm
Speakers/impedance: 6 Ω ~ 16 Ω

Tuner
FM tuning range: 87.50 MHz ~ 108.00 MHz
AM tuning range: MW: 522 kHz ~ 1,629 kHz
LW: 144 kHz ~ 288 kHz

CD player
CD Capacity: 3 CDs
Dynamic range: 85 dB
Signal-to-noise ratio: 90 dB
Wow and flutter: immeasurable

Cassette deck
Frequency response:
Normal type I: 50 Hz ~ 14,000 Hz
CrO type II: 50 Hz ~ 14,000 Hz
Metal type IVE: 50 Hz ~ 14,000 Hz (only for playback)
Wow and flutter:
0.15% (WRMS)

General
Power requirement: AC 230 V/50 Hz
Power consumption: 95 W (at operation)
14 W (on standby)
Dimensions (approx.): 245 mm x 315 mm x 368 mm (W/H/D)
Mass (approx.): 9.7 kg (21.4 lbs)

Supplied accessories
See page 6.

Design and specifications are subject to change without notice.

- 28 -

COLLEGAMENTO

- Spegnete la corrente dell'intero sistema prima di collegare gli altoparlanti all'amplificatore.
- L'impedenza nominale del modello SP-MXJ550/SP-MXJ552R è 6 Ω.
- Selezione per l'uso con un amplificatore a cui collegare un altoparlante con un'impedenza di carico di 6 Ω.
- La capacità di corrente massima del modello SP-MXJ550/SP-MXJ552R è 120 W. Un ingresso eccessivo causerà un suono anormale e possibili danni.
- Nel caso in cui i segnali descritti qui sotto vengono applicati agli altoparlanti, possono causare un sovraccarico e bruciare il filo cabloggio degli altoparlanti, anche se i segnali sono al di sotto dell'ingresso massimo ammesso.
- Assicuratevi di diminuire il livello del volume dell'altoparlante prima di procedere.
- 1) Generazione di rumore durante la sintonizzazione FM.
- 2) Segnali di alto livello che contengono dei componenti ad alta frequenza riprodotti da una cassetta o cassette nel modo di avanzamento rapido.
- 3) Si sentirà uno scatto quando accendete o spegnete la corrente degli alti componenti.
- 4) Si sentirà uno scatto quando collegate o scollegate i cavi con la corrente accesa.
- 5) Si sentirà uno scatto quando viene sostituita la cartuccia con la corrente accesa.
- 6) Si sentirà uno scatto quando vengono usati gli interruttori dell'amplificatore.
- 7) Oscillazione continua ad alta frequenza o suoni acuti da strumenti musicali elettronici.
- 8) Ululato quando usate i microfoni.

SPECIFICAZIONI

Tipo	• Reflex basso con 3-altoparlanti e 3 vie
Altoparlanti	
• Woofer	• Cono da 16 cm x 1
• Midrange	• Cono da 5 cm x 1
• Tweeter	• Cupola da 2 cm x 1
Capacità di potenza	• 120 W
Impedenza	• 6 Ω
Gamma di frequenza	• Da 45 Hz a 25 000 Hz
Livello della pressione sonora	• 86 dB/W/m
Dimensioni (L x A x P)	• 235 mm x 335 mm x 270 mm
Massa	• 3,7 kg, ciascuno

Il disegno e le specifiche sono soggetti a cambiamenti senza preavviso.

ANSLUTNING

- Slå av strömmen i alla apparater i ljudanläggningen innan högtalarna ansluts till förstärkaren.
- Nominell impedans för SP-MXJ550/SP-MXJ552R är 6 Ω. Se till att använda en förstärkare till vilken högtalare med en belastnings impedans på 6 Ω kan anslutas.
- Maximal effektkapacitet för SP-MXJ550/SP-MXJ552R är 120 W. Brus uppstår i ljudet och högtalarna kan skadas om de matas med för hög effekt. I situationerna som beskrivs nedan kan högtalarna också överbelastas och kabeltråden inne i högtalarna brännas sönder. Testa högtalarnas effekt inte här överkrivits.
- Sänk därför ljudstyrkan på följande:
 - 1) Brus under inställning av FM-radionäring.
 - 2) Starka, hörfrekventa signaler från ett kassettdäck under snabbspolning framåt.
 - 3) Ljudbangar som uppstår när andra apparater i anläggningen slås till och från.
 - 4) Skrapljud som uppstår när anslutningskabel ansluts eller kopplas från medan strömmen är på.
 - 5) Skrapljud som uppstår när pickupelementet på en skivspelare byts medan strömmen är på.
 - 6) Ljudbangar som uppstår när du använder förstärkarens omkopplare.
 - 7) Kontinuerliga, hörfrekvensvängningar eller hörfrekvent ljud från elektroniska musikinstrument.
 - 8) Akustisk återkoppling (ljusande ljud) vid bruk av mikrofoner.

TEKNISKA DATA

Typ	• 3-vägs, 3-element
Högtalarelement	
• Bas	• 16 cm kon x 1
• Mellanregister	• 5 cm kon x 1
• Diskant	• 2 cm dome x 1
Effektkapacitet	• 120 W
Impedans	• 6 Ω
Frekvensåtergivning	• 45 Hz - 25 000 Hz
Ljudtrycksnivå	• 86 dB/W/m
Yttermått (B x H x D)	• 235 mm x 335 mm x 270 mm
Vikt	• 3,7 kg per styck

Rätt till ändringar av utförande och specifikationer förbehålles utan föregående meddelande.

TILSLUTNING

- Slutk för strömmen till hele systemet før højttalerne forbindes til forstærkeren.
- Den nominelle impedans for SP-MXJ550/SP-MXJ552R er 6 Ω. Anvend en forstærker, hvortil der kan tilsluttes et højttalersystem med en belastningsimpedans på 6 Ω.
- Den maksimale belastningskapacitet for SP-MXJ550/SP-MXJ552R er 120 W. For kraftigt indgangs-signal vil resultere i unormal støj og muligvis beskadigelse.
- I tilfælde hvor højttalerne udsættes for signaler beskrevet nedenfor, kan der forekomme overbelastning og overbrænding af ledningerne i højttalerne selv om signalstyrken er under den maksimale tilladte. Husk derfor altid sænke højttalerstyrken i følgende:
 - 1) Støj under FM-afstemning.
 - 2) Signaler med høje niveauer der indeholder hørfrekvente komponenter dannet af en båndoptager der er indstillet til hurtig fremspoling.
 - 3) Klirring dannet når der tændes eller slukkes for strømmen til andre komponenter.
 - 4) Klirring der dannes når ledninger tilsættes eller tages ud af forbindelse mens der er tændt for strømmen.
 - 5) Klirring der dannes når pickuppen udklæbes mens der er tændt for strømmen.
 - 6) Klirring der dannes når forstærkerens omskiftere betjenes.
 - 7) Fortsat høj frekvensvængning, eller en højlydt dannet af et elektronisk instrument.
 - 8) Hyletoner når der anvendes en mikrofon.

SPECIFIKATIONER

Type	• 3-vejs basrefleks-højttaler med 3-elementer
Højttalere	
• Bas/højttaler	• 16 cm membran x 1
• Mellemløst/højttaler	• 5 cm membran x 1
• Diskant/højttaler	• 2 cm dome x 1
• Belastningskapacitet	• 120 W
• Impedans	• 6 Ω
• Frekvensområde	• 45 Hz - 25 000 Hz
• Ljudtrykniveau	• 86 dB/W/m
• Målt (B x H x D)	• 235 mm x 335 mm x 270 mm
• Vægt	• 3,7 kg / hver

Design og specifikationer kan blive ændret uden varsel.

LITÄNTÄ

- Kätkäse koko järjestelmän virta ennen kuin suoritat litännön kaiuttimista vahvistimeen.
- Mallin SP-MXJ550/SP-MXJ552R nimellinen impedanssi on 6 Ω. Valtta käyttää väkai vahvistin, johon voidaan liittää 6 Ω:n kuormusimpedanssin omaavat kaiuttimet.
- Mallin SP-MXJ550/SP-MXJ552R enimmäisteho on 120 W. Liiallinen antoteho aiheuttaa epänormaalia kointaa ja jopa vahinkoa.
- Tapauksissa, missä kaiuttimet joutuvat alla kuvattujen signaalien kohteeksi, vaikka signaali olisivat alle sallitun maksimian tehoon, ne saattavat aiheuttaa ylikuormitusta ja polttaa kaiuttimien johdot.
- Vähennä äänivahvistimen äänenvoimakkuutta jo ennalta:
 - 1) Kointaa FM-vahvistimen aikana.
 - 2) Kasettikäistä eteenpäinvalituksen aikana muodostuneita vahvat, korkeataajuuksisia komponentteja sisältäviä signaaleja.
 - 3) Klirääntä, joka syntyy silloin kun toisten osien virta kytketään ja katkaistaan.
 - 4) Klirääntä, joka syntyy silloin kun kytketään tai irrotetaan johtoja virran ollessa päällä.
 - 5) Klirääntä, joka syntyy silloin kun vaihdetaan hylsy virran ollessa päällä.
 - 6) Klirääntä, joka syntyy silloin kun käytetään vahvistimen kytkimiä.
 - 7) Jatkuva korkea värinäily tai elektronisesti tuotettu korkea soittimen ääni.
 - 8) Ulinaa mikrofonin käytettäessä.

TEKNISÉTIEDOT

Tyyppi	• 3-ita, 3 koirnen kaiuttimen basorefleksi
Kaiuttimet	
• Basso	• 16 cm kartiomuotoinen x 1
• Keski-kaiutin	• 5 cm kartiomuotoinen x 1
• Diskantti	• 2 cm kōhök x 1
• Enimmäisteho	• 120 W
• Impedanssi	• 6 Ω
• Taajuusalue	• 45 Hz - 25 000 Hz
• Äänenpainetaso	• 86 dB/W/m
• Mått (L x A x S)	• 235 mm x 335 mm x 270 mm
• Paino	• 3,7 kg / kaiutin

Okedet muutokset pidetään...



EN, GE, FR, NL, SP, IT, SW, FI, DA

1299JYMRJEM

MX-J550R
MX-J552R

-MEMO-

Block diagrams

■ MAIN/CASSETTE/CD section

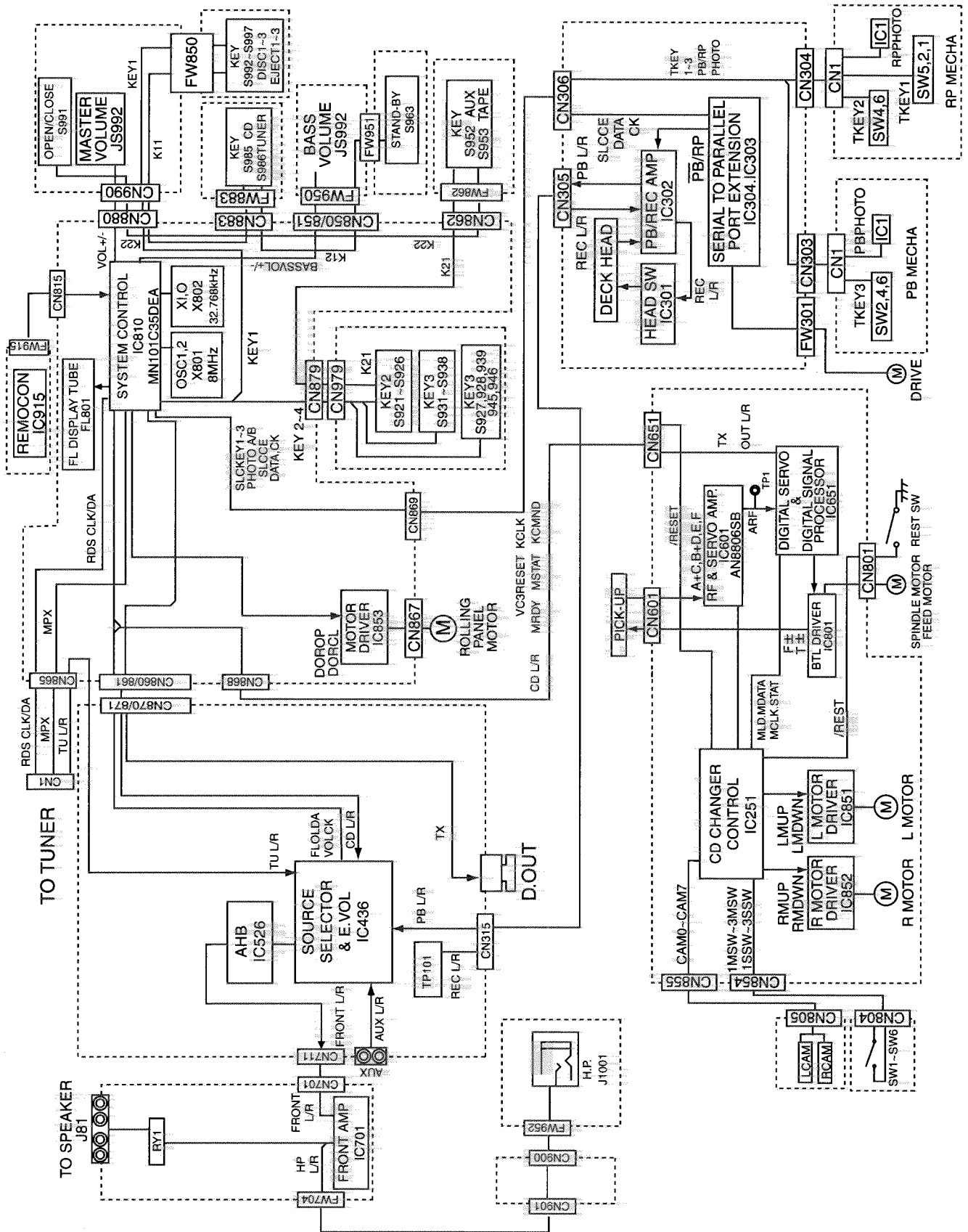

MX-J550R
MX-J552R

■ TUNER section

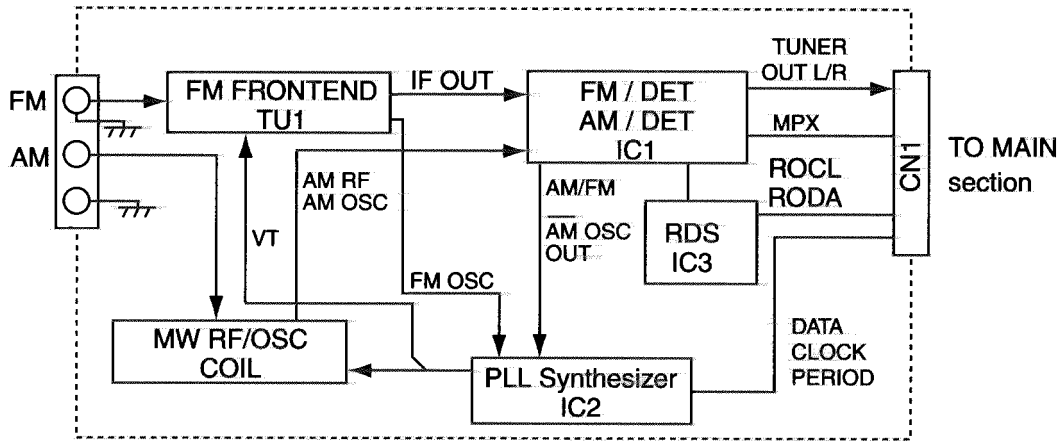

Standard schematic diagrams

■ Power transformer section

POWER SUPPLY BLOCK

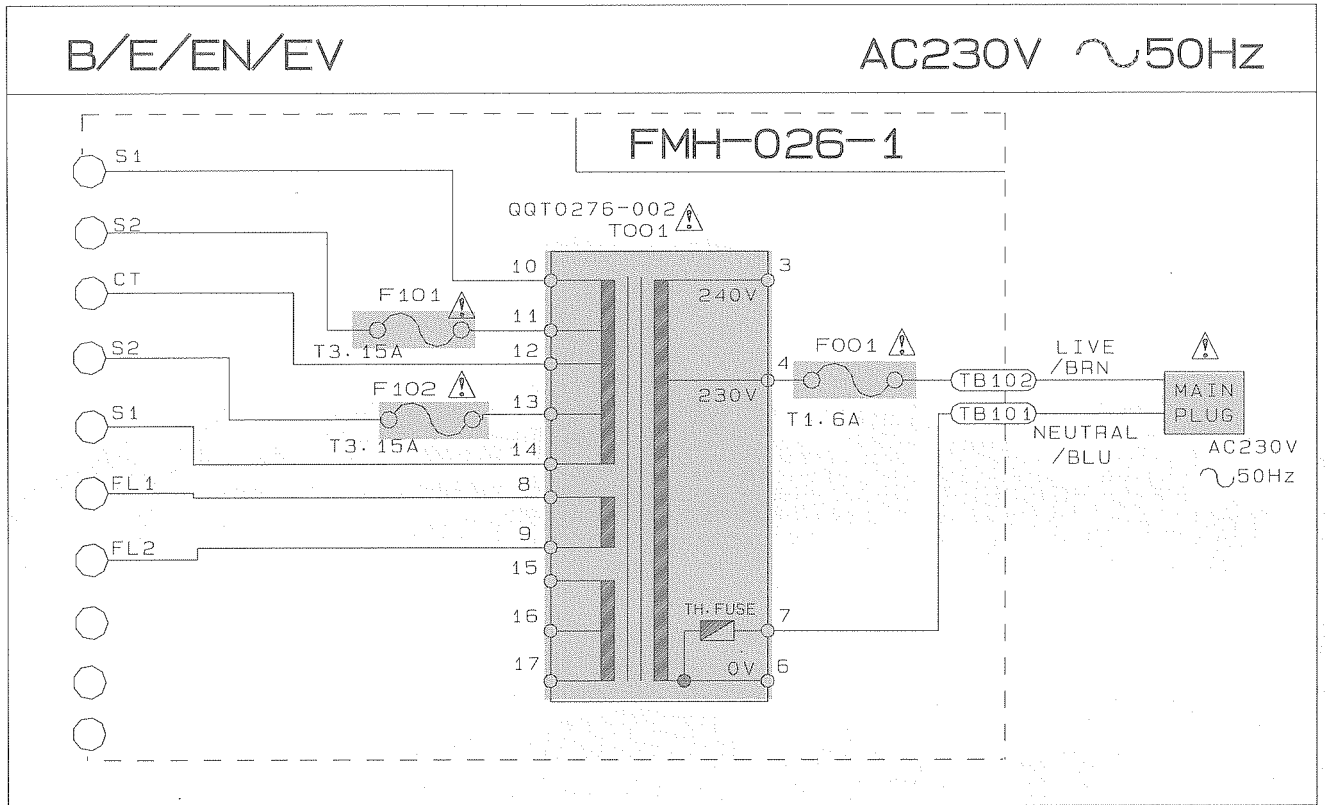

VERSION CODES

- B : U. K.
- E : CONTINENTAL EUROPE
- EN : NORDIC COUNTRIES
- EV : EASTERN EUROPE

A

B

C

D

EXPLANATION OF OVERALL OF SCHEMA.

MODEL MX-J550R/CA-MXJ550R/CA-MXJ552R

SHEET NUMBER	MODEL NUMBERS TO BE APPLIED	CIRCUITS DESCRIPTION
1/7	CA-MXJ550R CA-MXJ552R MX-J550R	. PRIMARY WITH MAINS TRANSFORMER
2/7	CA-MXJ550R CA-MXJ552R MX-J550R	. DC REGULATORS/AUDIO OUTPUT
3/7	CA-MXJ550R CA-MXJ552R MX-J550R	. EXTERNAL INPUT. SOURCE SELECTOR SWITCH
4/7	CA-MXJ550R CA-MXJ552R MX-J550R	. TUNER RF/IF/FM MULTIPLEX
5/7	CA-MXJ550R CA-MXJ552R MX-J550R	. FL DISPLAY. SYSTEM CONTROL LSI. USER CONTROL KEYS
6/7	CA-MXJ550R CA-MXJ552R MX-J550R	. TAPE DECK MECHANISM CONTROL . TAPE CIRCUITS SUCH AS PRE-AMP AND BIAS
7/7	CA-MXJ550R CA-MXJ552R MX-J550R	. CD SERVO AND CD SYSTEM CONTROL . CD CHANGER MECHANISM CONTROL

V
Z

 Parts are safety assurance parts.
When replacing those parts make sure to use the specified.

■ Power amplifier & regulator section

5
4
3
2
1

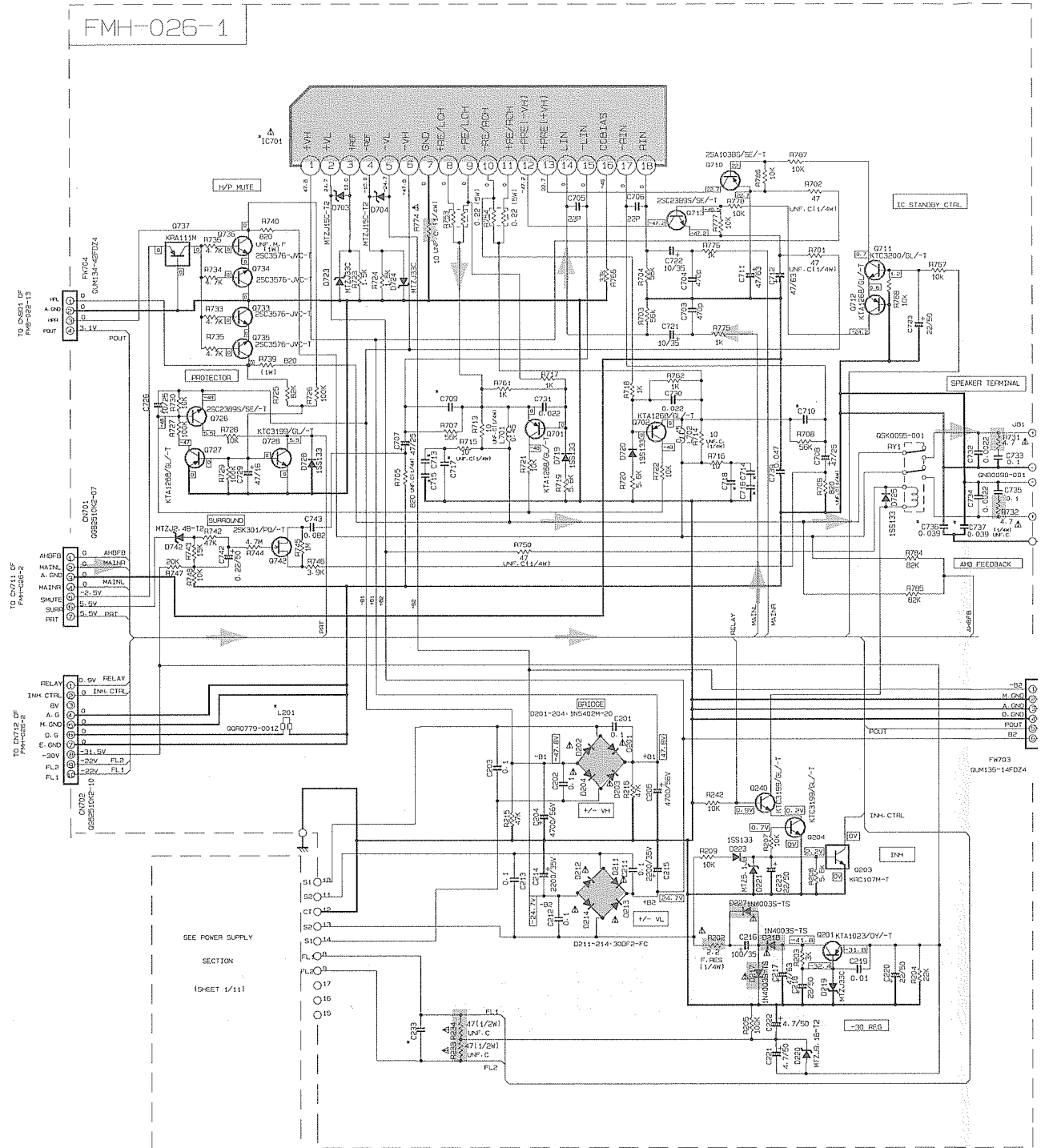

NOTES

1. VOLTAGES ARE DC-MEASURED WITH A DIGITAL VOLT METER OR OSCILLOSCOPE WITHOUT INPUT SIGNAL.
CONDITION --- ALL NOISE VOL. MAX. BASS OFF
2. UNLESS OTHERWISE SPECIFIED
RESISTORS ARE 1/4W 1% CARBON RESISTOR.
ALL RESISTANCE VALUES ARE IN OHMS (Ω).
ALL CAPACITORS ARE CERAMIC CAPACITOR OR POLYMER CAPACITOR.
ALL CAPACITANCE VALUES ARE IN nF (10⁻⁹F).
ALL INDUCTANCE VALUES ARE IN mH (10⁻³H).
ALL E-CAPACITORS ARE SHOWN IN THE FORM OF CAPACITANCE (μF)/RATED VOLTAGE (V).
ALL DIODES ARE 1SS133

▶ MAIN signal

VERSION	CA-MX_0550R B-E, EN, EV	CA-MX_0552R E, EN
C713-C714-C715-C716	0.047	0.047
C717-C718	NONE	NONE
R393-R393-R394	SHORT BB1, BB2, BB3	SHORT BB1, BB2, BB3
R393	SHORT BB4	SHORT BB4
R360	2.2 (1/4W) F.RES	2.2 (1/4W) F.RES
R361	4.7 (1/4W) F.RES	4.7 (1/4W) F.RES
C233	0.01	0.01
C736/C737	USED	USED
R395/R396	USED	USED
R373/R374	NONE	NONE
IC701	STR412-000	STR412-000
L201	USED	USED
C705/C710	4.7P	4.7P

R TERMINAL

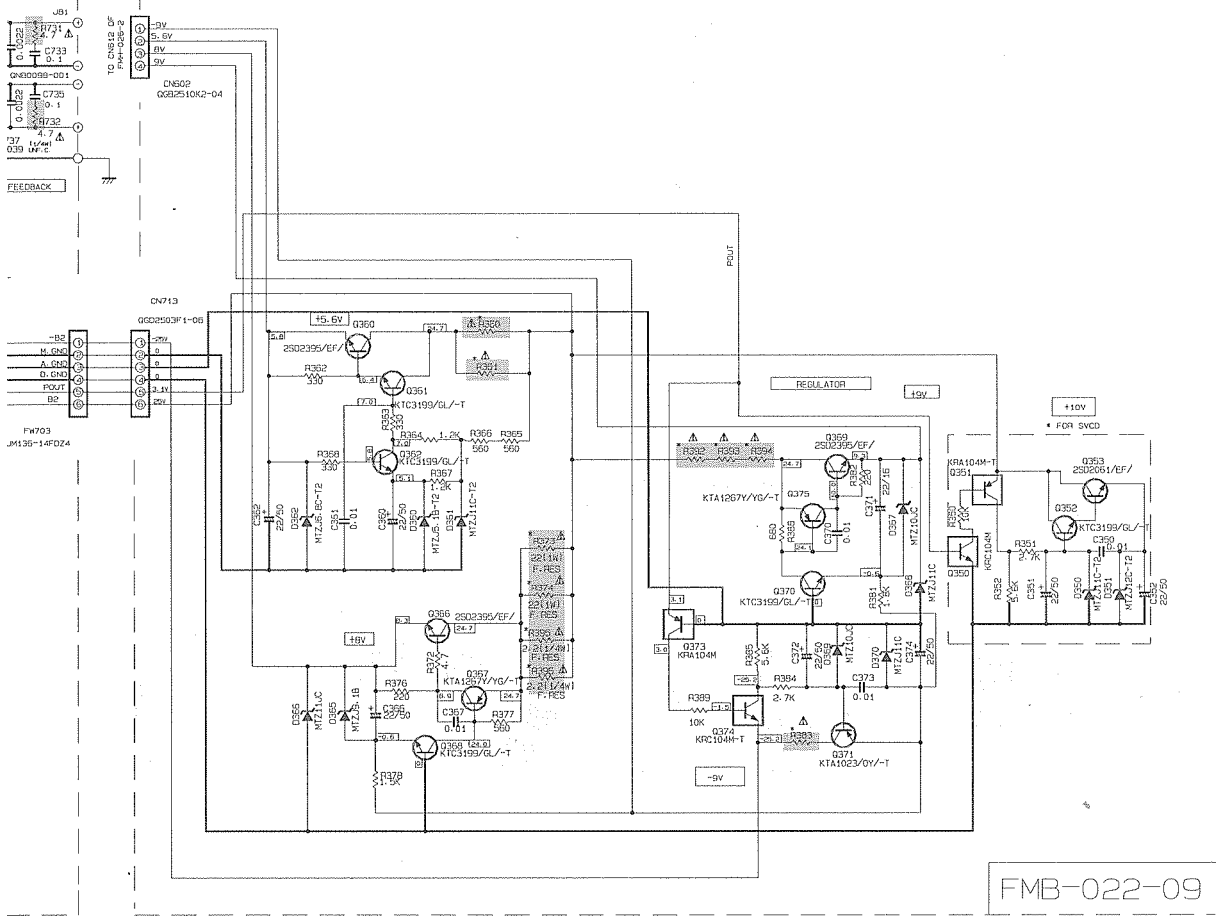

⚠ Parts are safety assurance parts.
When replacing those parts make
sure to use the specified.

SHEET 2/7

Function & main amplifier section

SHEET 5/7
TO CN860 OF
FMH-022-01

SHEET 5/7
TO CN861 OF
FMH-022-01

5

4

3

2

1

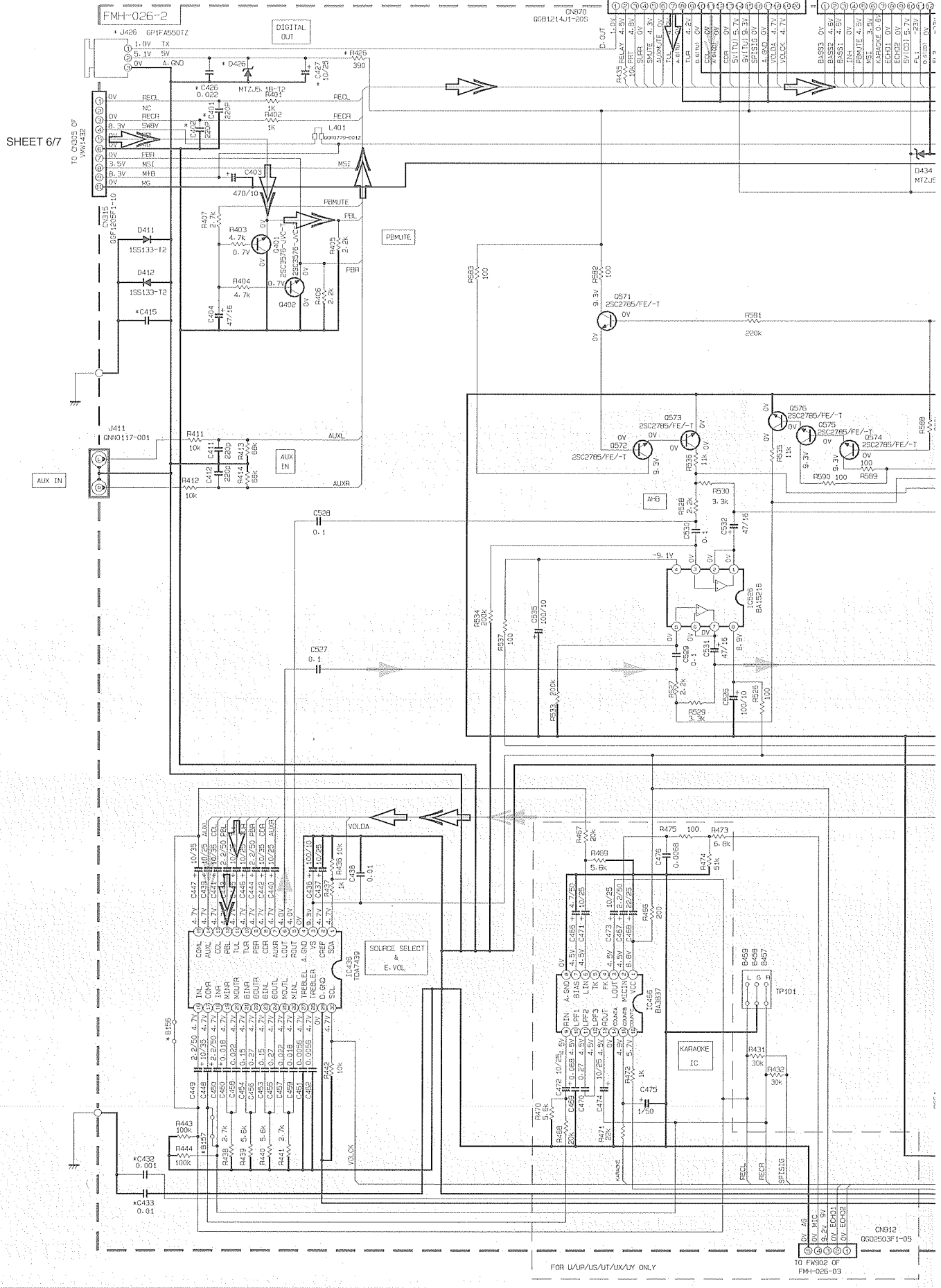

HEET 5/7
TO CN851 OF
FM9-022-01

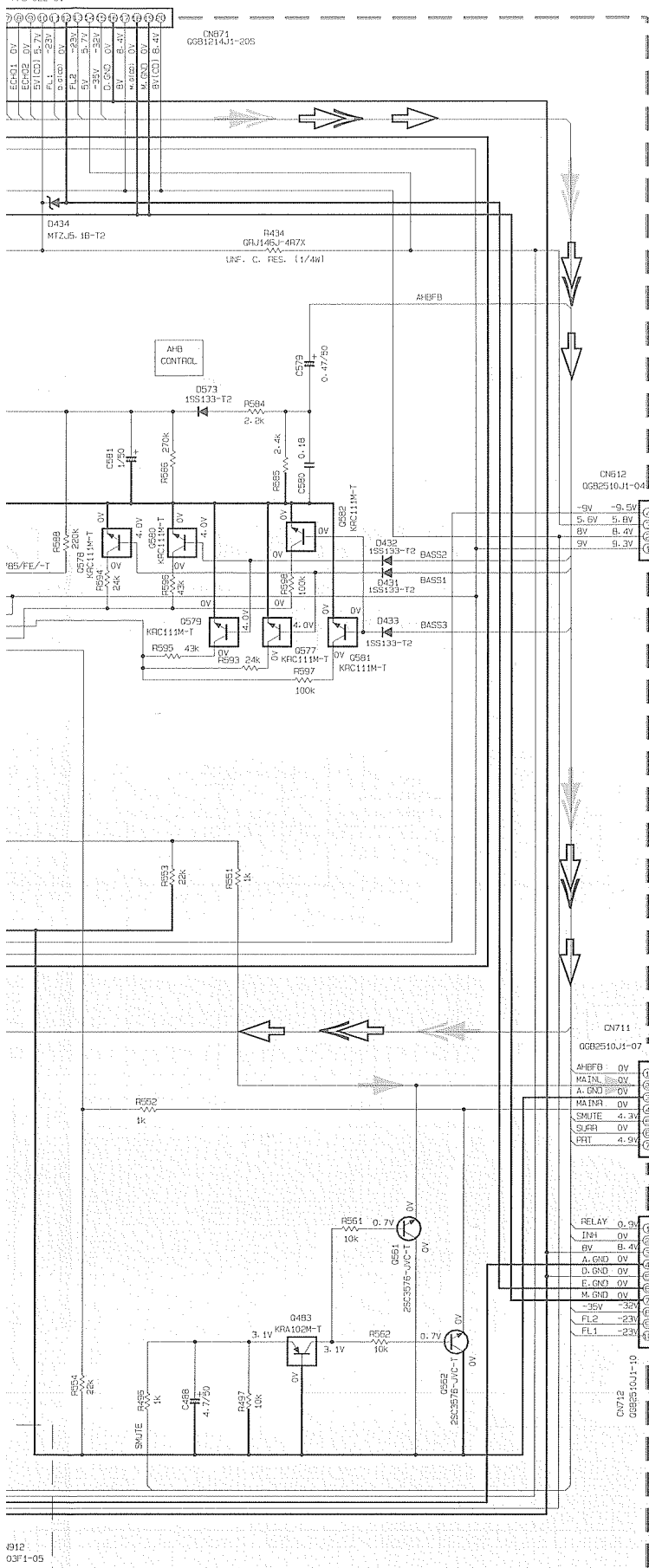

* MARK

MODEL	CA-MXJ550R	CA-MXJ552R
VERSION	B-E-EN-EV	E-EN
DIGITAL OUT		
C426	USED	USED
C427	USED	USED
D426	USED	USED
J426	USED	USED
R426	USED	USED
C401	USED	USED
C402	USED	USED
C415	0.0022	0.0022
C431	USED	USED
C432	USED	USED
C433	USED	USED
L401	USED	USED
EVC		
B356	USED	USED
B357	USED	USED

FROM CN802 OF
FM9-022-09

SHEET 2/7

- NOTES
- VOLTAGES ARE DC-MEASURED WITH A DIGITAL VOLT METER OR OSCILLOSCOPE WITHOUT INPUT SIGNAL.
CONDITION --- AUX POES: VOL. MTR: BASS OFF
 - UNLESS OTHERWISE SPECIFIED:
RESISTORS ARE 1/4W ±5% CARBON RESISTOR.
ALL RESISTANCE VALUES ARE IN OHM(S).
ALL CAPACITORS ARE CERAMIC CAPACITOR OR MYLAR CAPACITOR.
ALL CAPACITANCE VALUES ARE IN nF(10⁻⁹F).
ALL INDUCTANCE VALUES ARE IN μH(10⁻⁶H).
ALL E-CAPACITORS ARE SHOWN IN THE FORM OF CAPACITANCE (nF)/RATED VOLTAGE (V).
ALL DIODES ARE 1SS133

FROM CN701 OF
FM9-025-1

SHEET 2/7

FROM CN702 OF
FM9-025-1

SHEET 2/7

- ➡ MAIN signal
- ➡ CD signal
- ➡ TAPE P.B. signal
- ➡ TUNER signal

■ Tuner selection

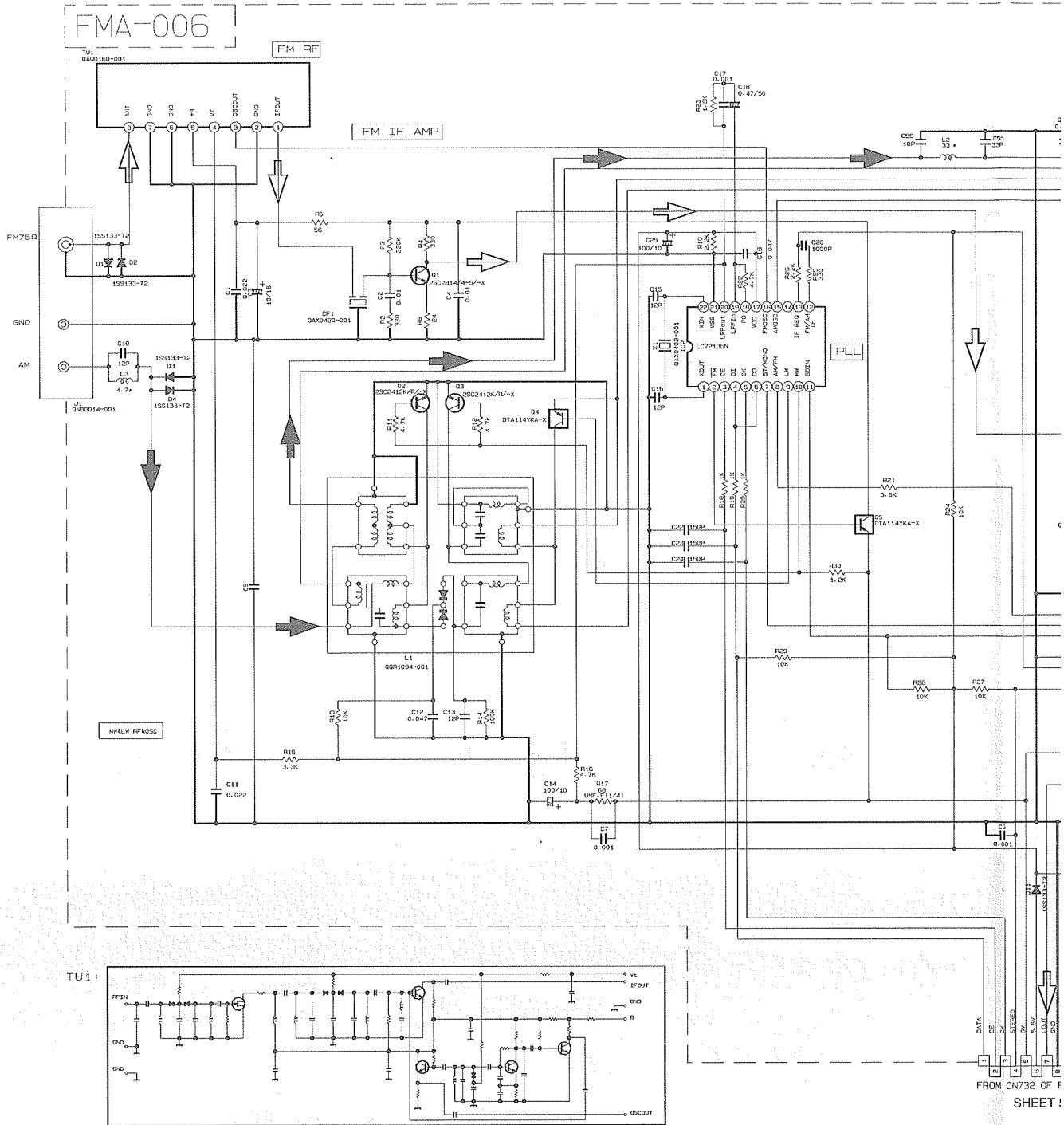

CONDITION	PIN NO.	1	2	3	4	5	6	7	8	9	10	11	12	13	14	15	16	17	18	19	20	21	22	23	24	25	26	27	28	29	30
IC1	FM NO SIGNAL	3.6	8.9	3.6	3.6	0	5.0	5.0	8.9	8.9	1.3	0.1	0	0.9	7.8	7.8	4.3	4.3	4.3	4.3	3.4	3.4	2.8	3.4	0	0	3.5	3.5	3.6	3.6	2.7
IC1	FM 60dB STEREO	3.6	8.9	3.6	3.6	0	5.0	5.0	8.9	8.9	1.3	4.3	0	0.9	7.8	7.8	4.3	4.3	4.3	4.3	3.4	3.4	2.8	3.4	0	0	3.6	3.6	3.6	3.6	2.7
IC1	AM NO SIGNAL	3.5	9.0	3.5	3.5	0	5.0	5.1	9.0	2.6	1.3	0	0	0.9	4.7	5.5	4.3	4.3	4.3	4.3	3.3	3.2	2.8	ust	0.7	0.7	3.6	3.6	3.6	3.6	2.1
IC2	FM NO SIGNAL	2.5	0	0	5.0	4.9	5.0	7.9	7.8	3.6	6.1	5.1	0	0	0	0	2.5	5.1	0.9	0.9	3.9	0	2.3								

FROM CN732 OF F SHEET !

NOTES

1. VOLTAGES ARE DC-MEASURED WITH A DIGITAL VOLT METER.
2. ALL RESISTORS ARE 1/8W ±5% METAL GLAZE RESISTOR.
3. ALL RESISTANCE VALUES ARE IN OHM(Ω).
4. ALL CAPACITANCE VALUES ARE IN P(F).
5. ALL E. CAPACITORS ARE SHOWN IN THE FORM OF CAPACITANCE (pF)/RATED VOLTAGE (V).
6. SI DIODES (D) ARE ALL 1S133-T THAT CAN BE CHANGED TO SIMILAR DIODE SUCH AS MA165 OR HSS104J.
7. PARTS NO. OF TRANSISTORS ARE AS FOLLOWS.
 Q1 2SC2814/4-5/-X Q2-Q3 2SC2412K/R/-X
 Q4-Q5 DTA114YKA-X

6. INSIDE OF DIGITAL TRANSISTORS ARE SHOWN AS FOLLOWS.

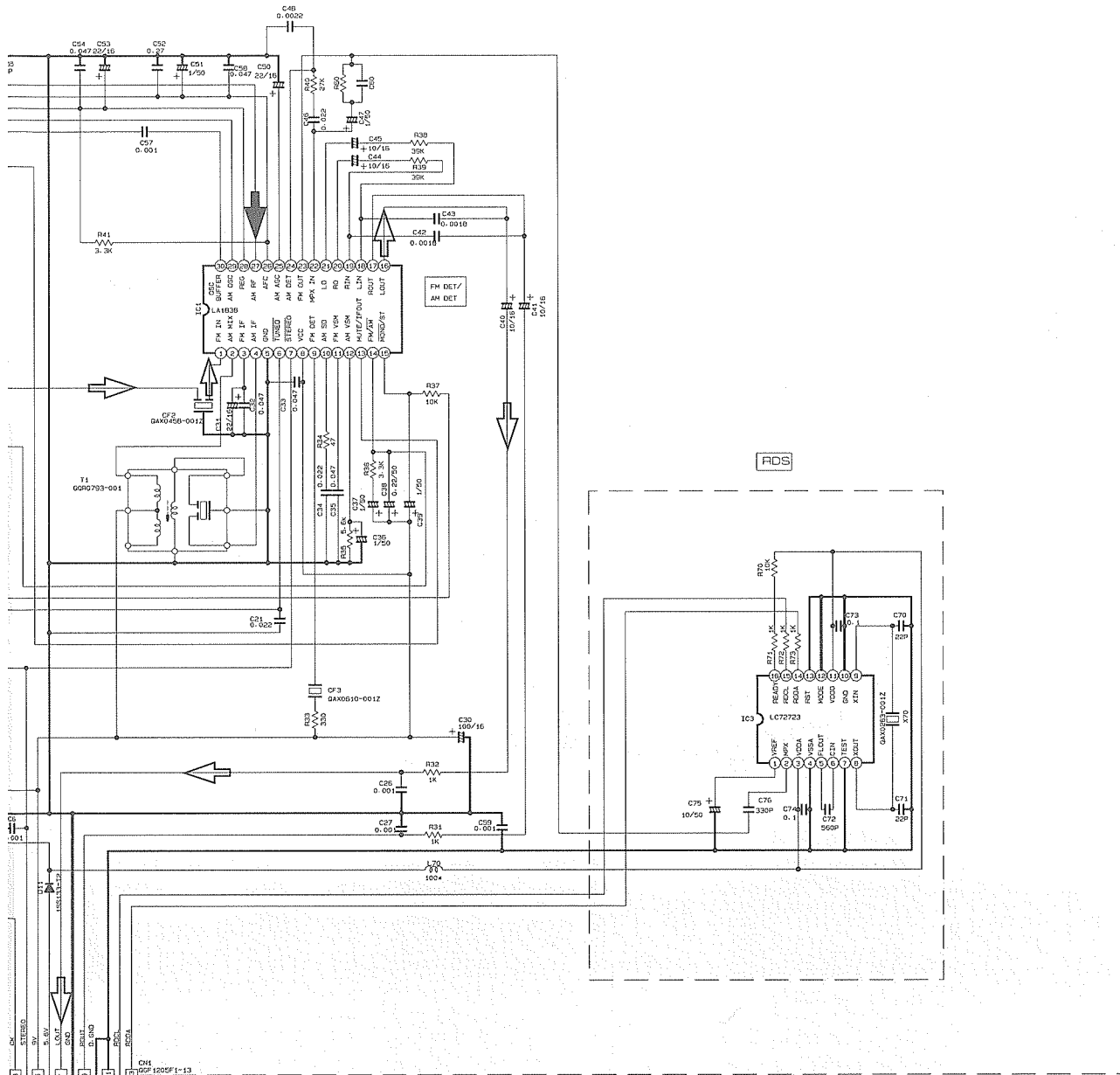
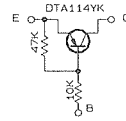

1 CN732 OF FMB-022-01
SHEET 5/7

Tr. NO.	Q1			Q5					
PIN NO.	E	C	B	E	C	B			
FM 87.5MHz NO SIGNAL	0	7.1	0.85	8.9	8.8	0			
AM 52KHz NO SIGNAL	0	0	0	9.0	0	9.9			
Tr. NO.	Q2			Q3			Q4		
PIN NO.	E	C	B	E	C	B	E	C	B
AM 52KHz NO SIGNAL	0	0	0.7	0	0	0.7	0	3.6	0.7
AM 144KHz NO SIGNAL	0	0	0.3	0	0.3	0.3	3.6	3.6	3.6

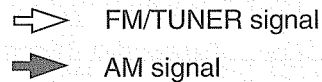

3	3.0
6	2.7
6	2.7
6	2.1

FL Display & system controller selection

5

4

3

2

1

SHEET 4/7

SHEET 3/7

SHEET 3/7

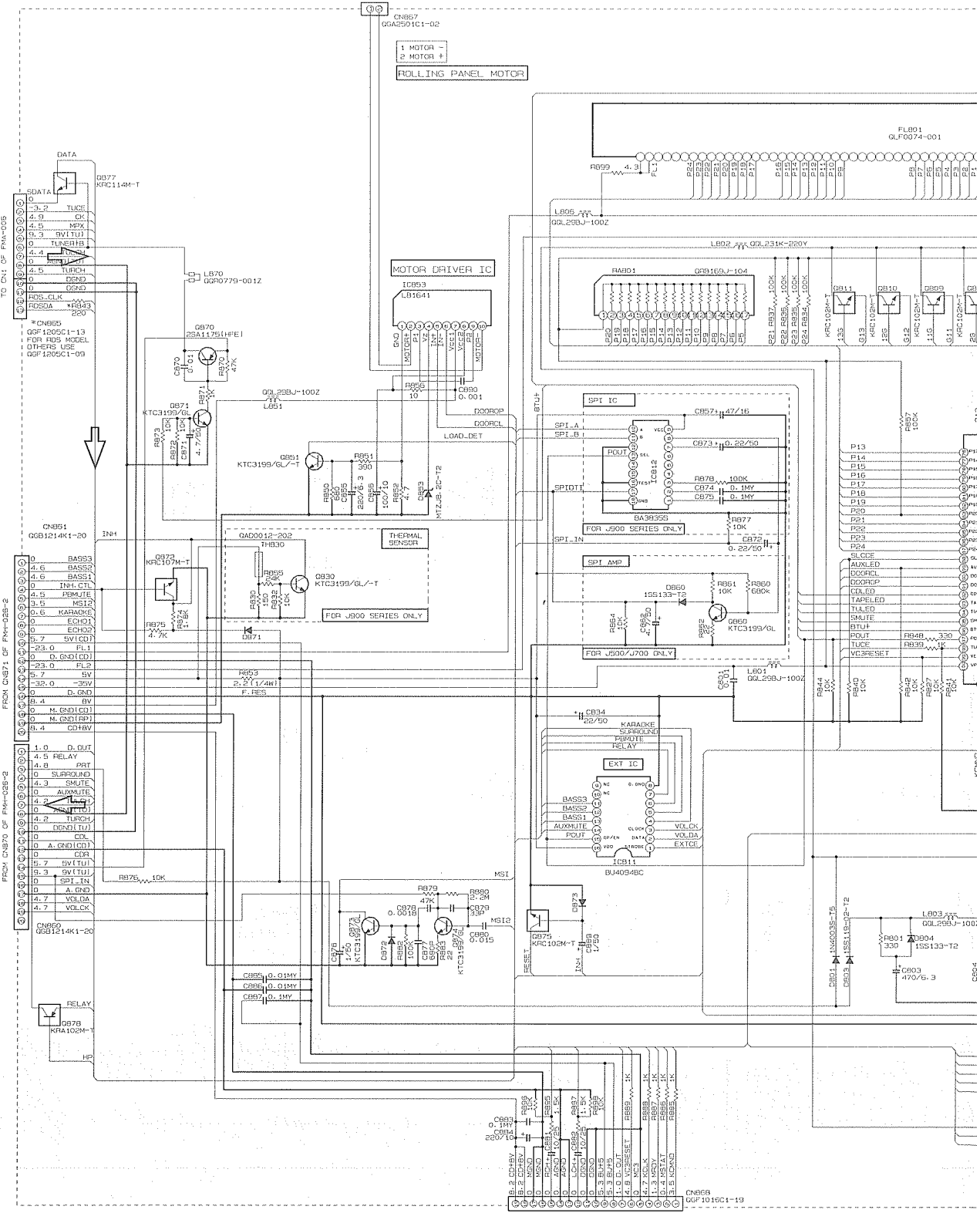

* MARK

	CA-MXJESOR B-E-EN-EV CA-MXJESOR E-EN
R964	330K
R951	330K
R933	75K
R994	330K
D950, D952, D951, D951	NONE
D953, D954, D953, D951	NONE
R950, R957, R936, R939	NONE
D950, D991	NONE
S941, S942, S943, S944	GS90BGS-C01Z
L1001, L1002	GL231K-470Y
C1001, C1002	3900P
L1003	GG90775-001Z
R925, R926	NONE
R943	USE
R901	QAX0416-001Z

TO CN51 OF EHW10729
(CD CHANGER)
SHEET 7/7

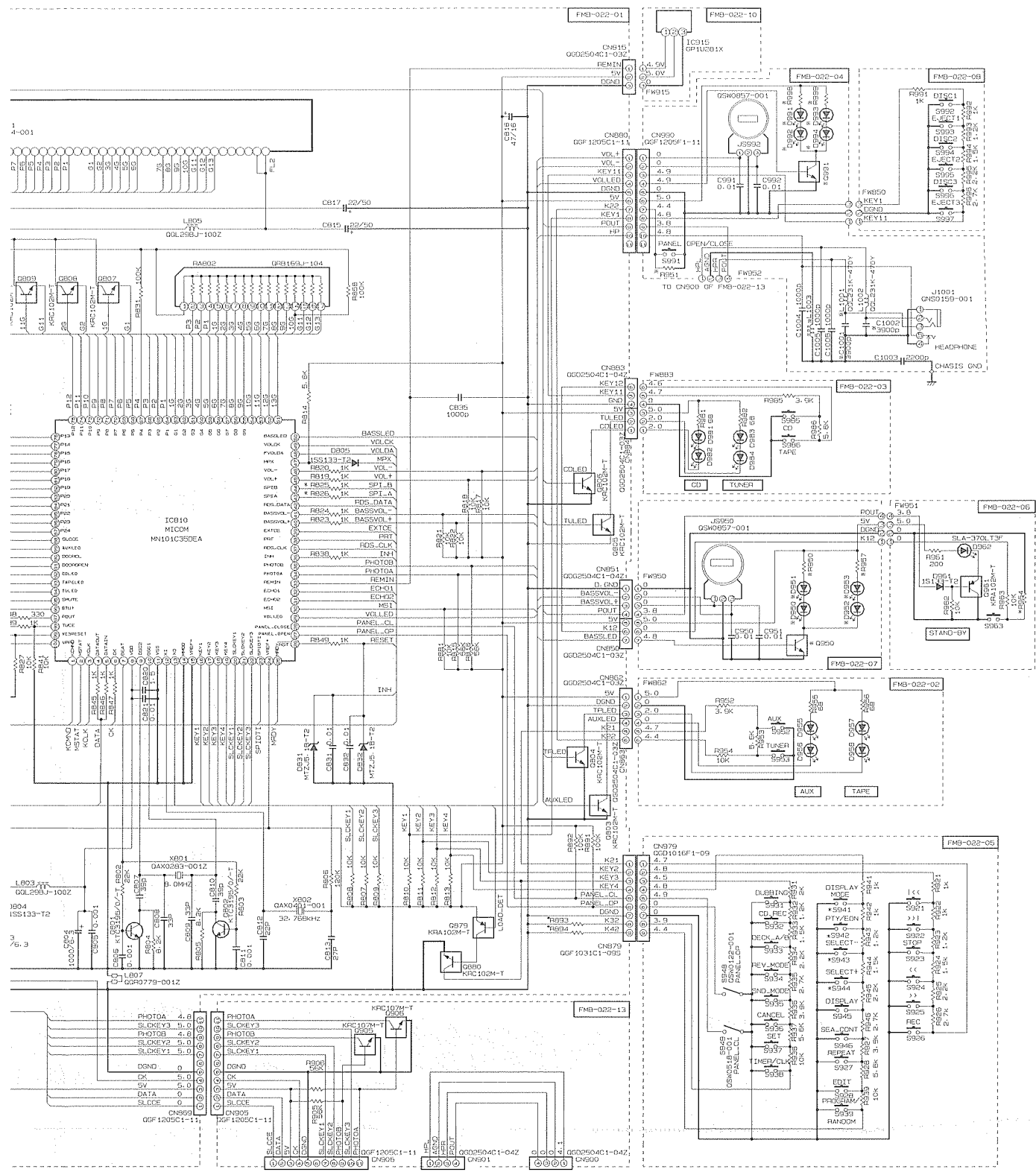

TO CN306 OF VMW1432 FROM FW704 OF FMB-026-1 FROM FW952 OF FMB-022-04
SHEET 7/7 SHEET 2/7

- NOTES
- VOLTAGES ARE DC-MEASURED WITH A DIGITAL VOLT METER OR OSCILLOSCOPE WITHOUT INPUT SIGNAL.
 - CONDITION — 600 MHz, 100 MHz, 1000 Hz.
 - UNLESS OTHERWISE SPECIFIED:
 - RESISTORS ARE 1/4W, ±5% CARBON RESISTOR.
 - ALL RESISTANCE VALUES ARE IN OHMS.
 - ALL CAPACITORS ARE CERAMIC CAPACITOR OR POLYMER CAPACITOR.
 - ALL CAPACITANCE VALUES ARE IN PICO-FARADS (pF).
 - ALL INDUCTIVE VALUES ARE IN MILLI-HENRYS.
 - ALL CAPACITORS ARE SHOWN IN THE FORM OF CAPACITANCE (CAPACITANCE (pF) VOLTAGE (V)).
 - ALL DIMENSIONS ARE IN MILLIMETERS.

TUNER signal

Head amplifier & mechanism control section

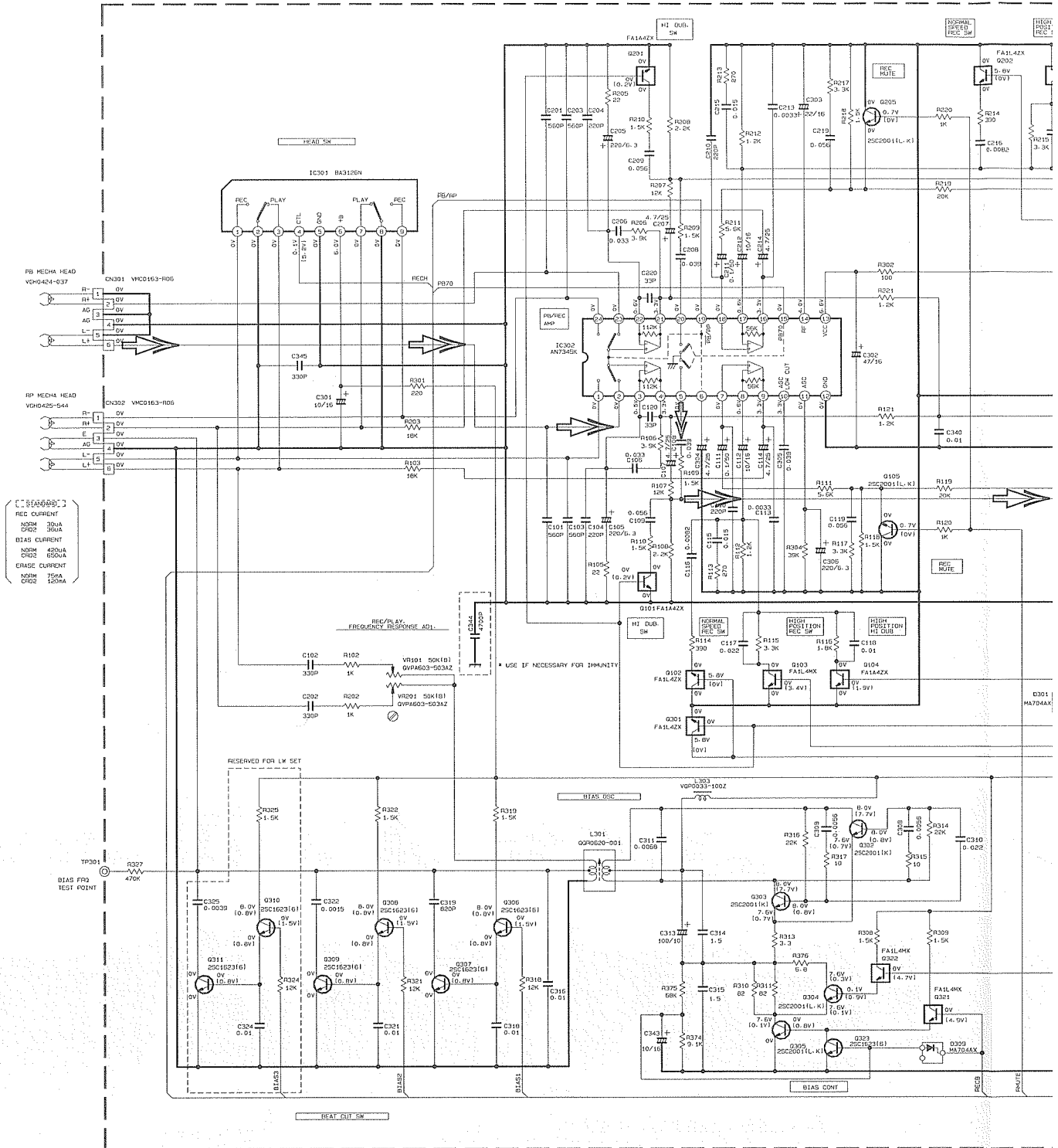

REC CURRENT
NOM 30mA
CR2 30mA

BIAS CURRENT
NOM 400mA
CR2 650mA

CRASE CURRENT
NOM 75mA
CR2 100mA

- NOTES
1. VOLTAGES ARE DC-MEASURED WITH A DIGITAL VOLT METER OR OSCILLOSCOPE WITHOUT INPUT SIGNAL. () IS INVERT MODE
 2. UNLESS OTHERWISE SPECIFIED
ALL RESISTANCE VALUES ARE IN OHM[Ω].
ALL CAPACITORS ARE CERAMIC CAPACITOR.
ALL CAPACITANCE VALUES ARE IN μF [P=PF].
ALL INDUCTANCE VALUES ARE IN mH [mH].
ALL E-CAPACITORS ARE SHOWN IN THE FORM OF CAPACITANCE (μF)/RATED VOLTAGE (V).
PP = POLYPROPYLENE CAPACITOR

TABLE 1. DIGITAL TR LIST

PART NO	CONSTRUCTION	REF. NO		
FA14M	4K	Q318	FA14M	Q317
FA14Z	1K	Q101/Q291 Q104/Q294	FA14M	Q103/Q293 Q319
FA14Z	4K	Q102/Q292 Q391		Q320/Q321/Q322

5
4
3
2
1

CASSETTE MECHA CONTROL CIRCUIT [SLC]

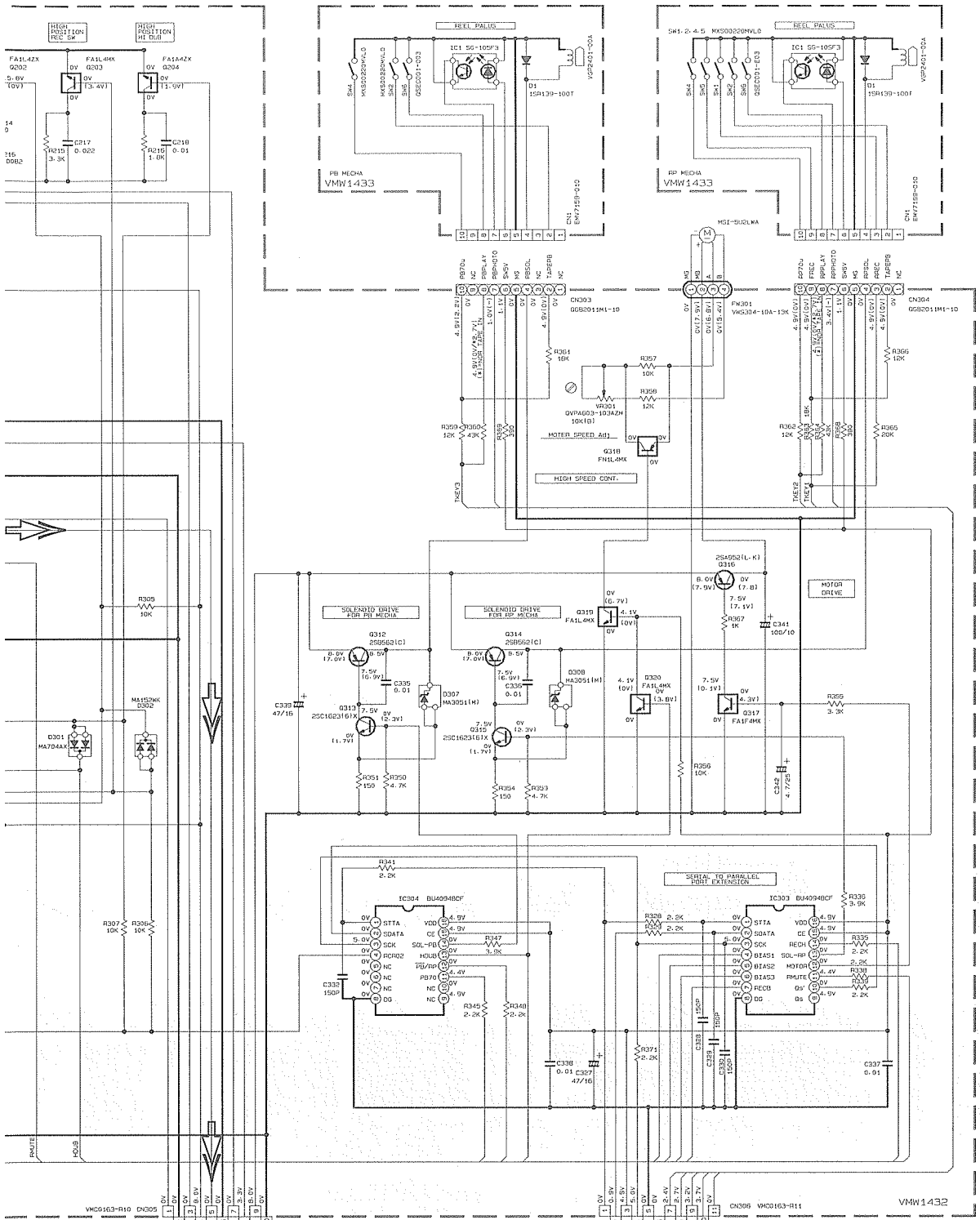

REEL PALUS
 FB MECHA VMW1433
 FP MECHA VMW1433
 MOTOR SPEED SH1
 HIGH SPEED CONT.
 SOLENOID DRIVE FOR FB MECHA
 SOLENOID DRIVE FOR FP MECHA
 MOTOR DRIVE
 SERIAL TO PARALLEL PORT EXTENSION

FROM PRE-AMP CIRCUIT
 FROM MICON CIRCUIT

CD Servo & CD Mechanism control selection

5

4

3

2

1

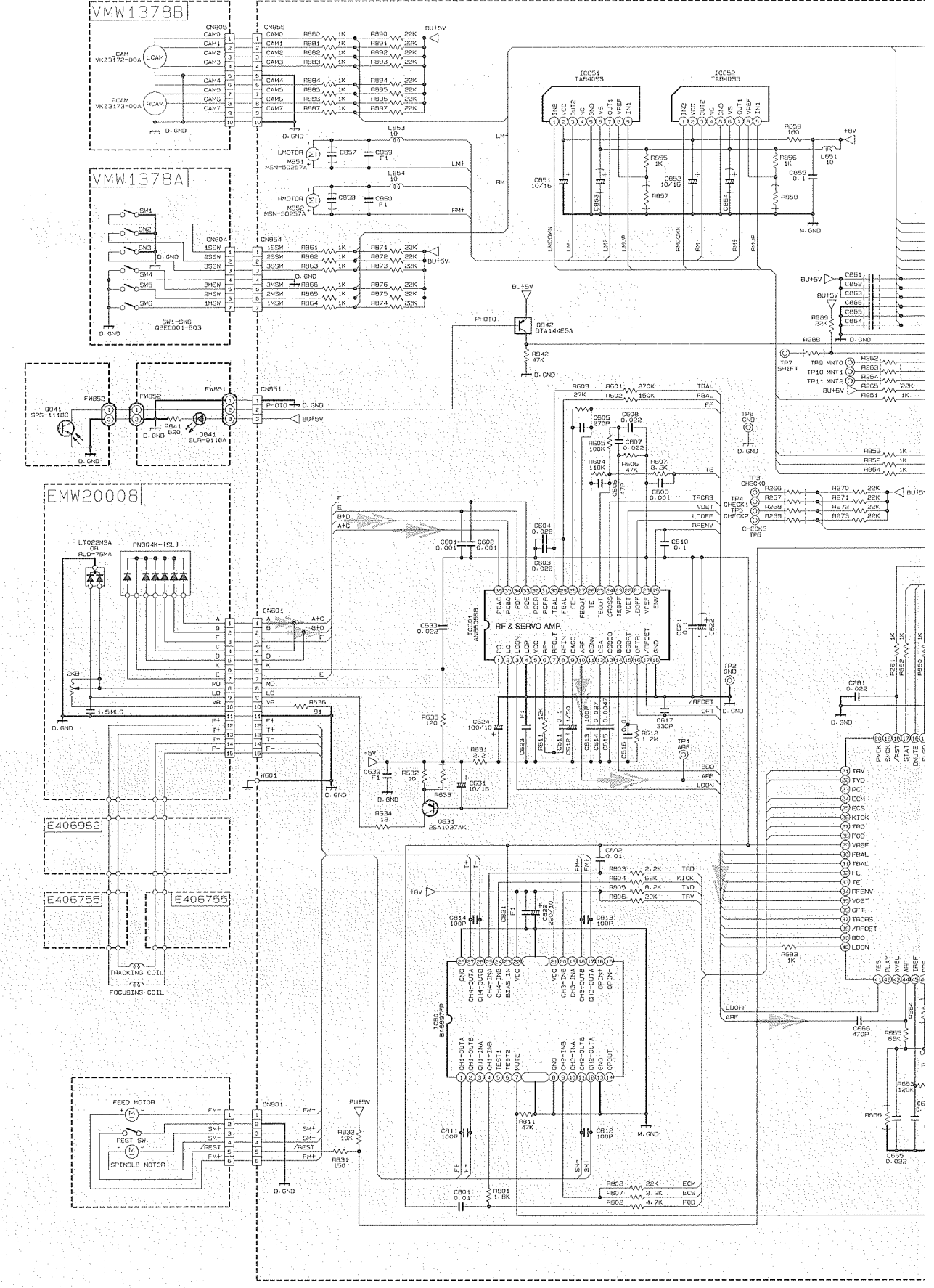

A

B

C

D

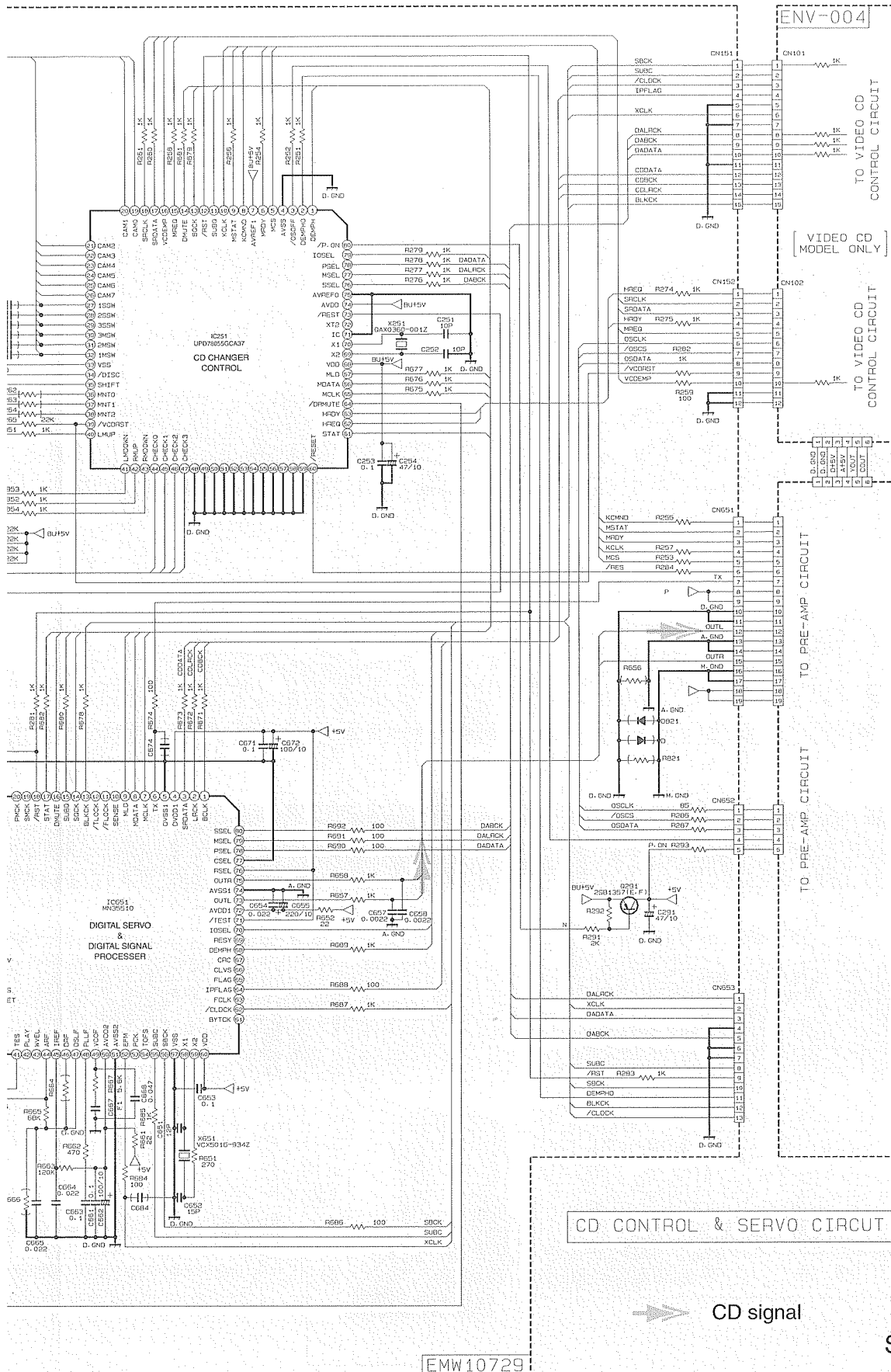

Printed circuit board

■ Main & preamplifier board

5
4
3
2
1

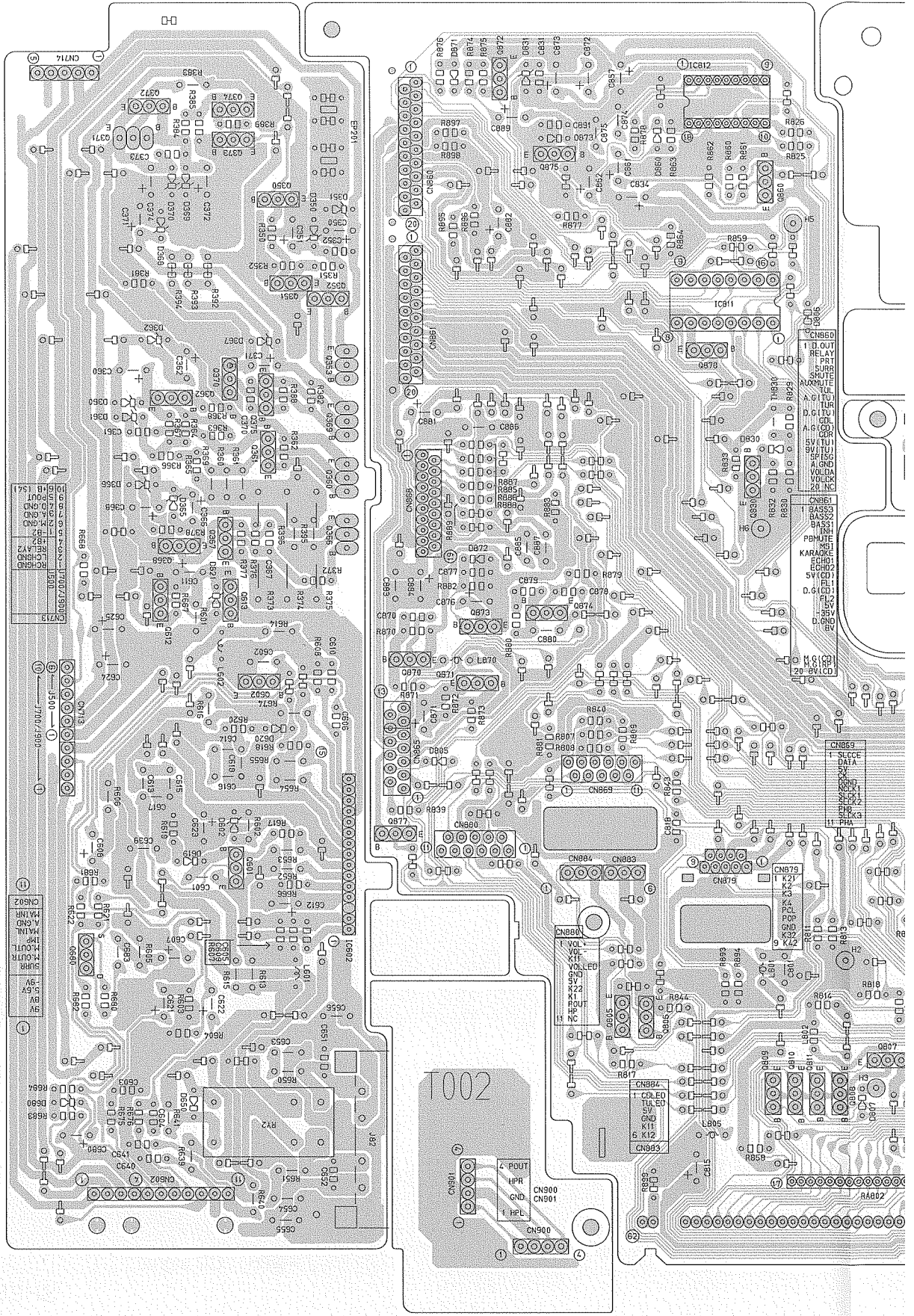

A B C 2-10 D

Input/output & power board

5

4

3

2

1

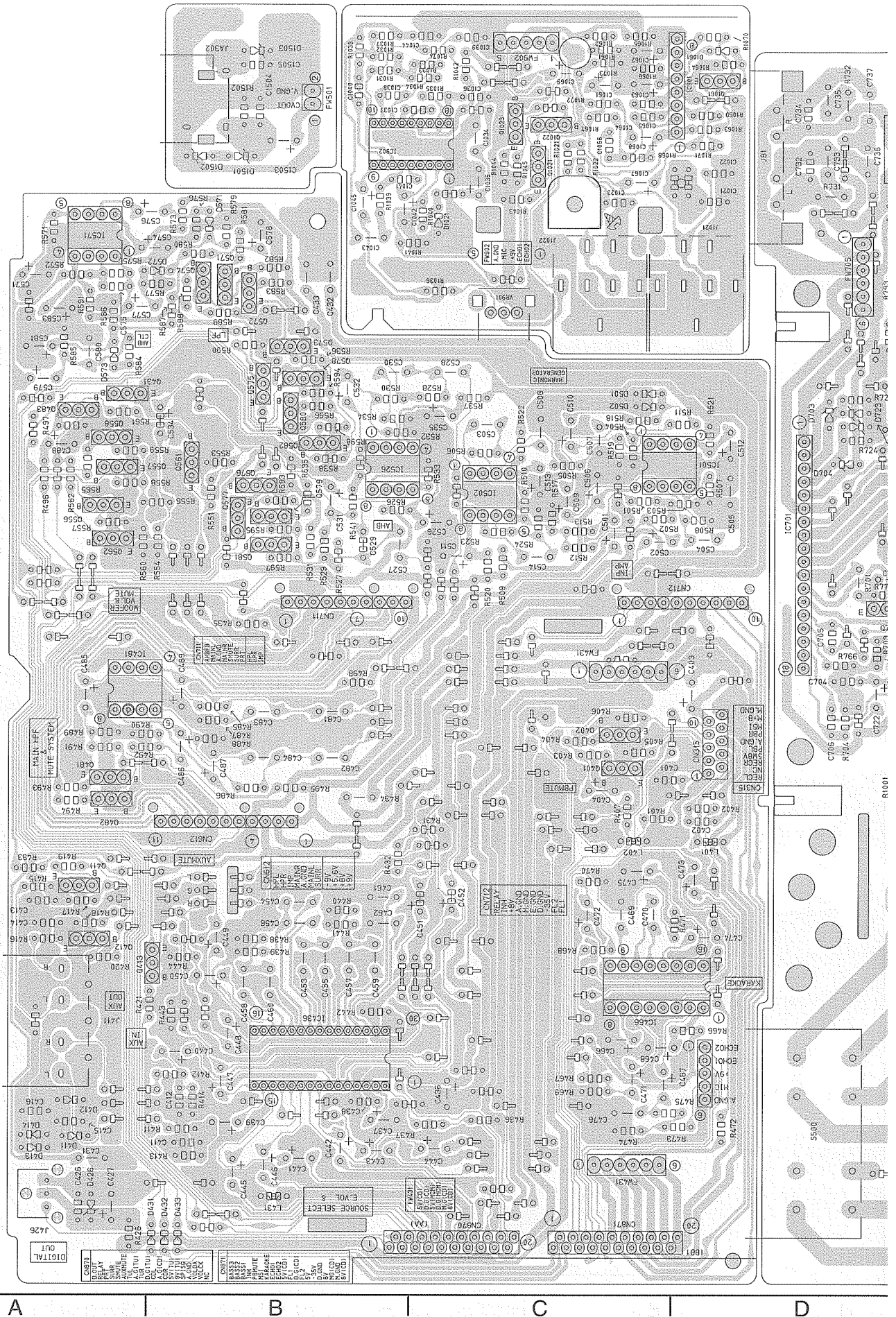

A

B

C

D

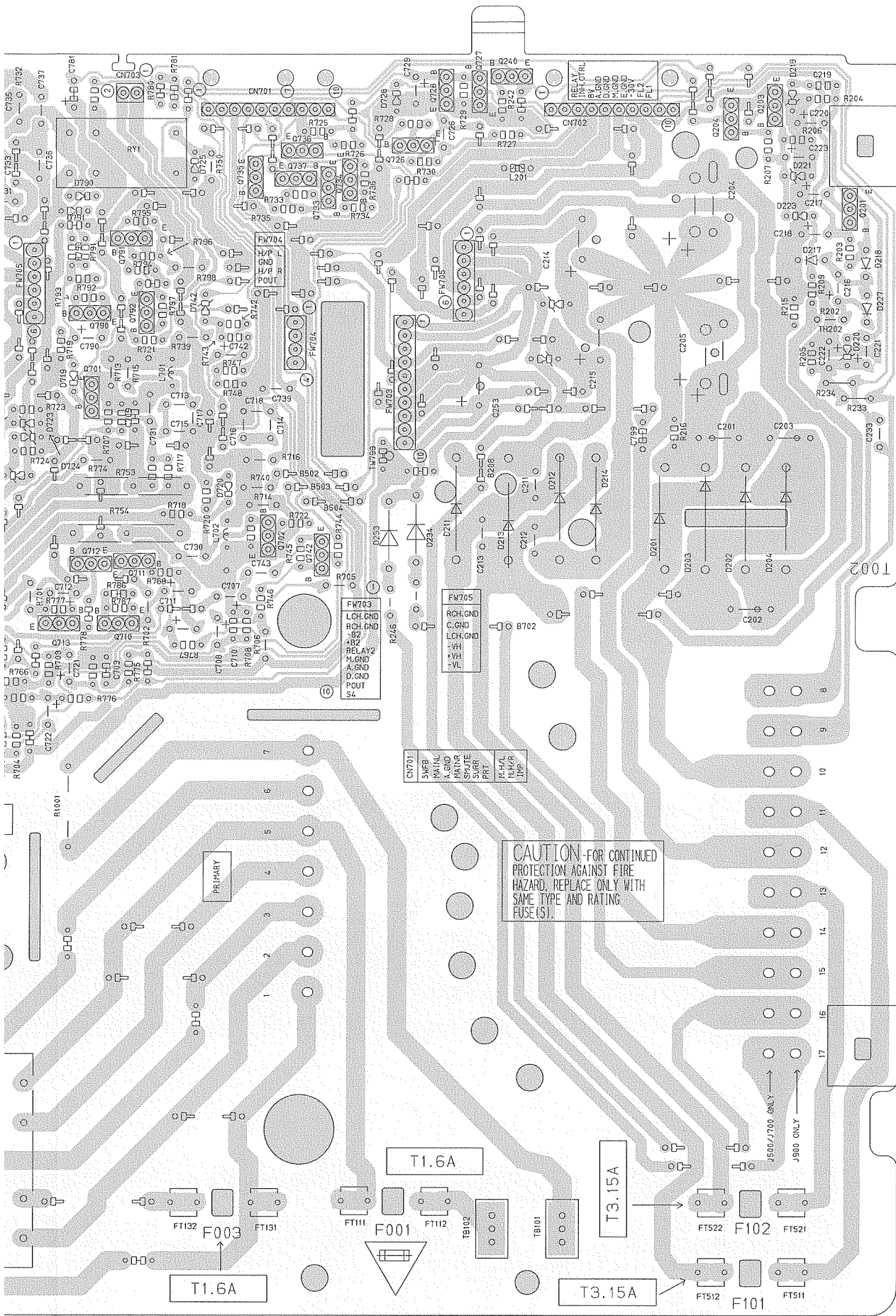

CAUTION-FOR CONTINUED PROTECTION AGAINST FIRE HAZARD, REPLACE ONLY WITH SAME TYPE AND RATING FUSE(S).

- CN701 5WFB
- MAIN
- A.GND
- MAINR
- SHUTE
- SURE
- PAI
- M.H/L
- M.H/P
- TYP

- FW703
- LCH.GND
- RCH.GND
- C.GND
- LCH.GND
- VH
- +VH
- VL
- +VL
- RELAY2
- M.GND
- A.GND
- D.GND
- POUT
- S4

T1.6A

T1.6A

T3.15A

T3.15A

J500/J700 ONLY

J500 ONLY

■ CD Tray section switch board

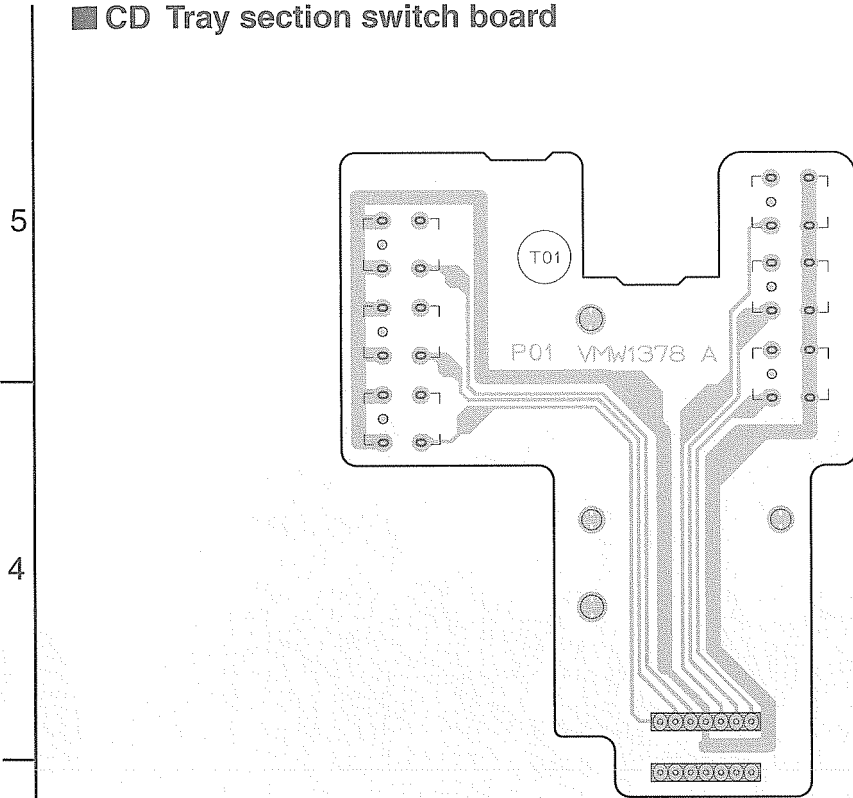

■ Can switch board

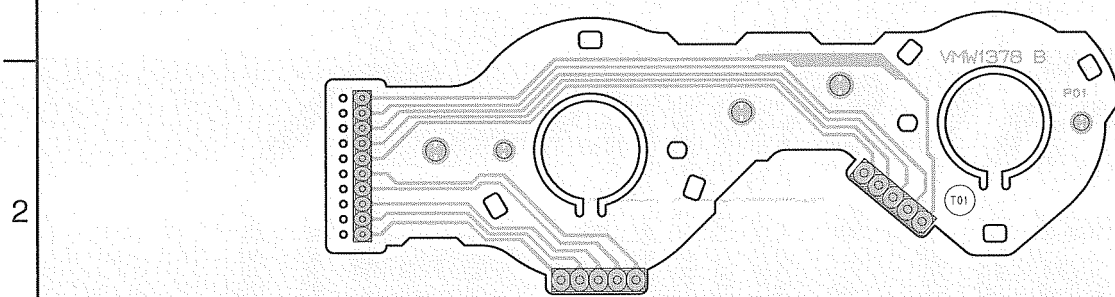

■ CD Servo control board

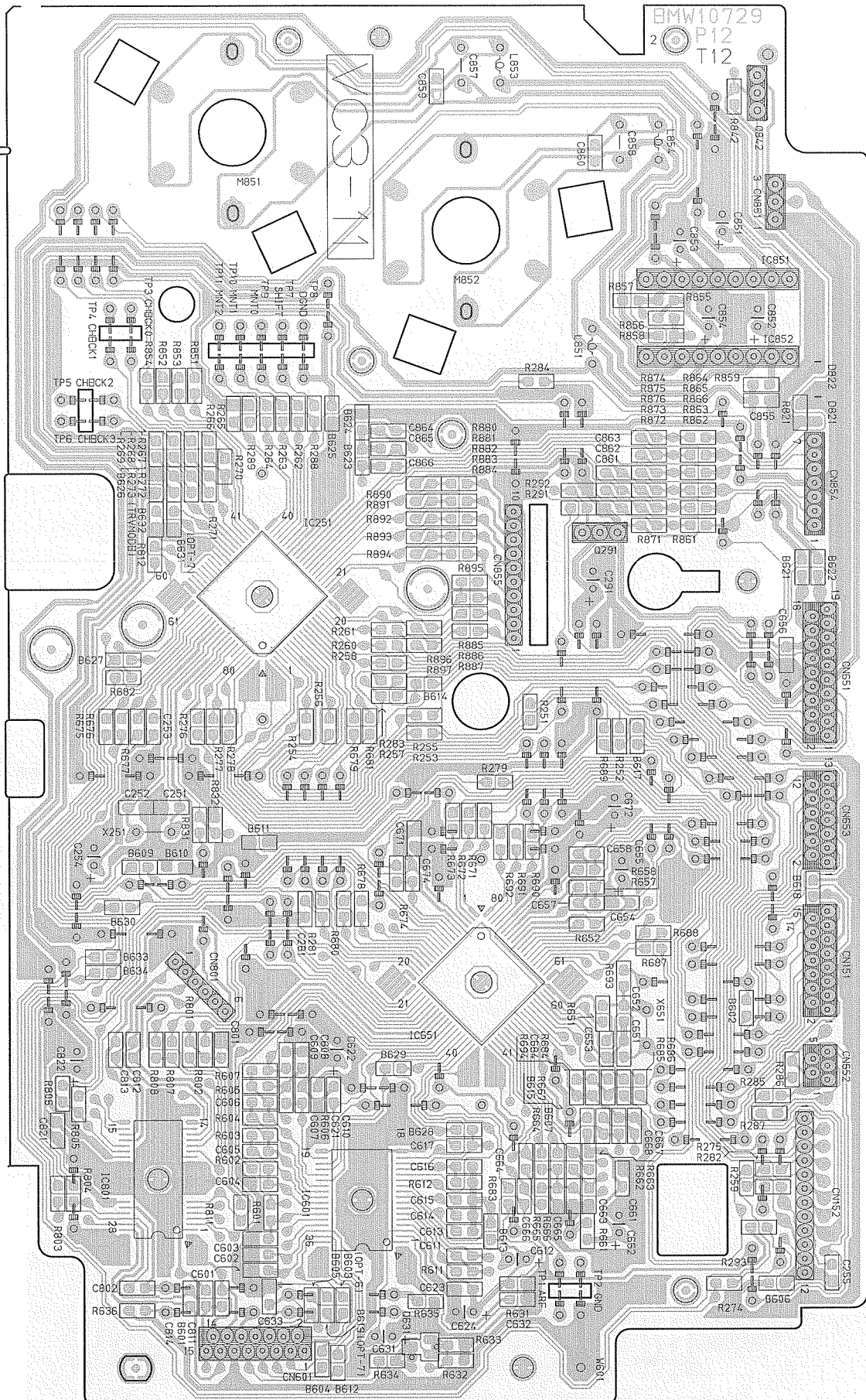

D | E | F | G | H

■ Cassette mechanism board

5
4
3
2
1

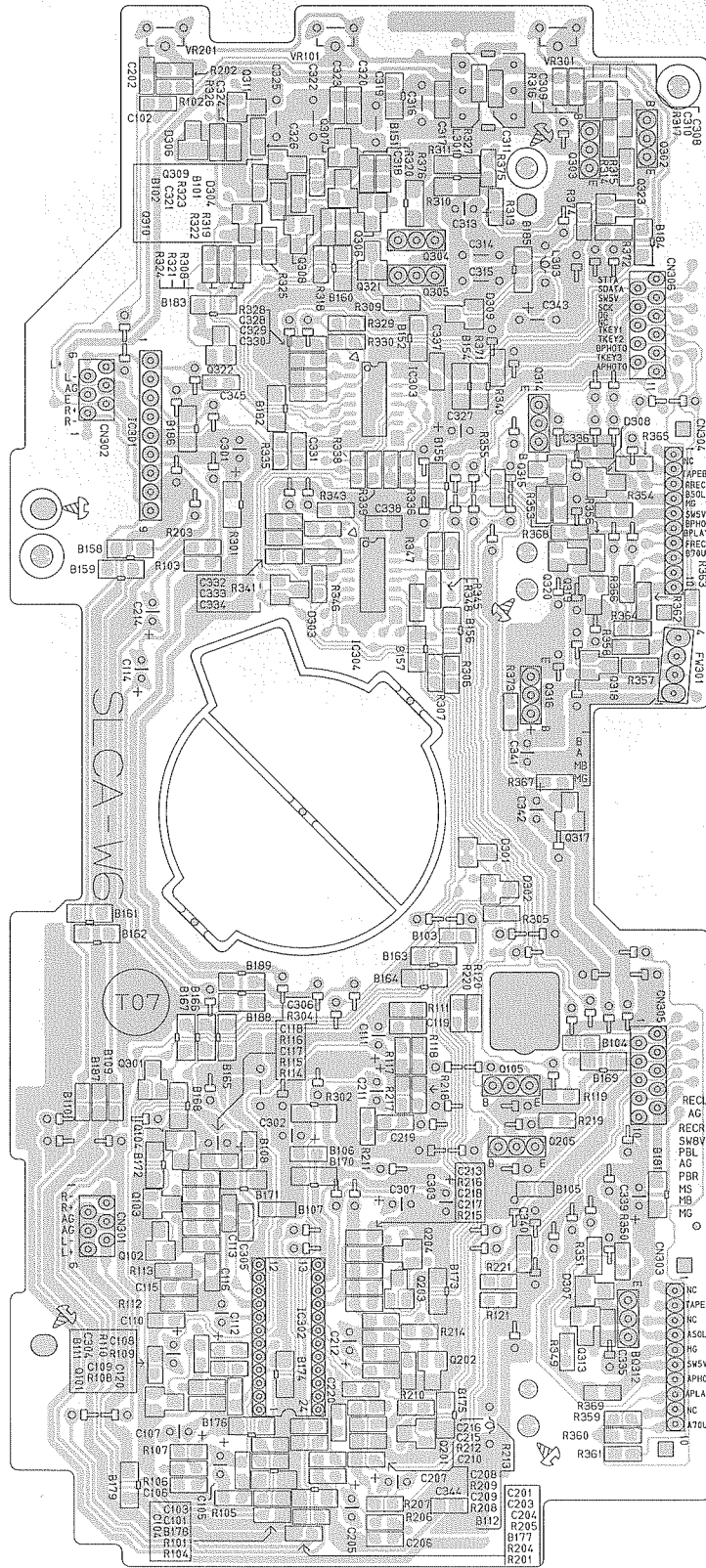

MX-J550R
MX-J552R

■ Tuner board

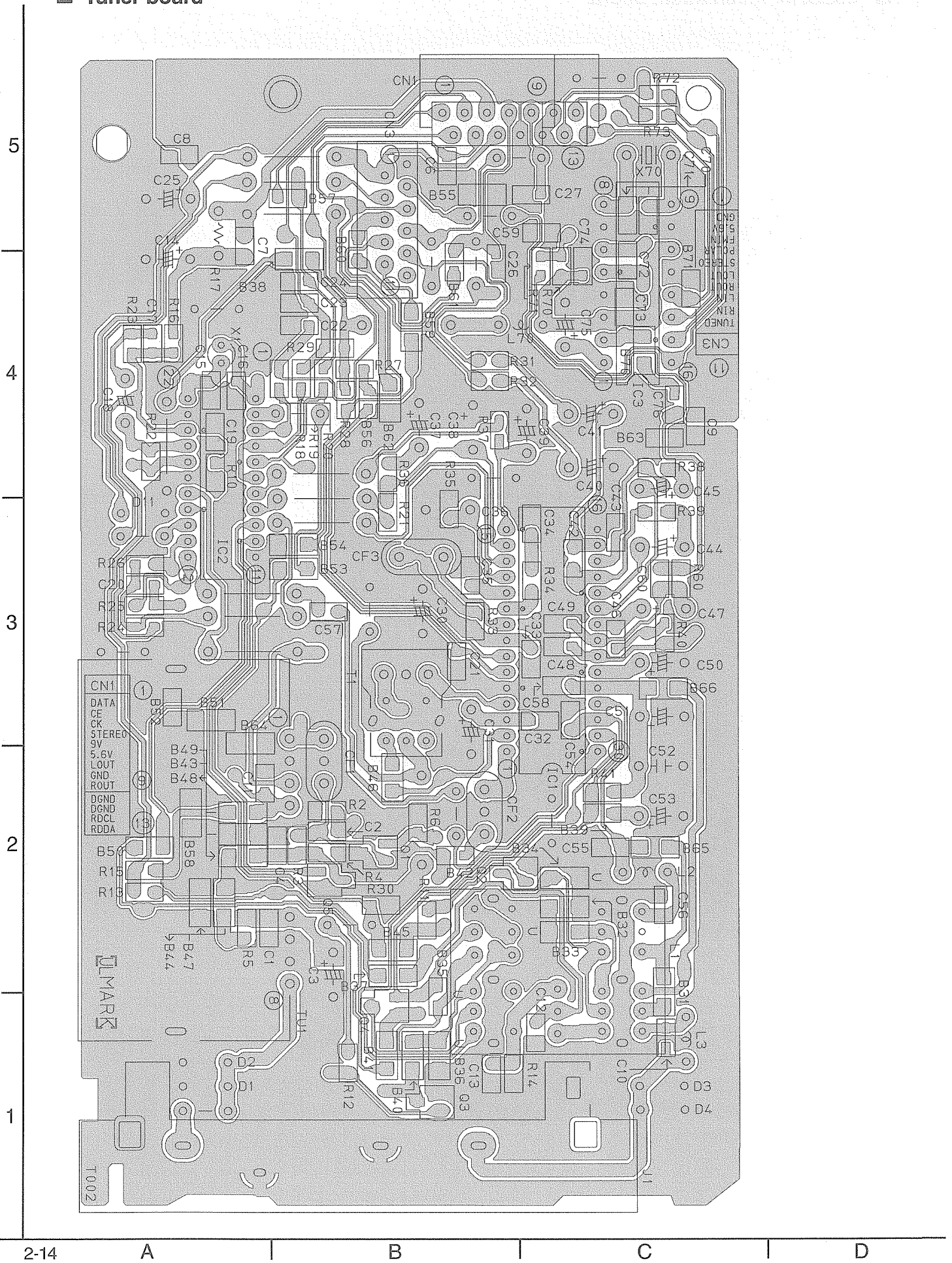

PARTS LIST

[CA-MXJ550R]
[CA-MXJ552R]

* All printed circuit boards and its assemblies are not available as service parts.

<p style="text-align: center;">CA-MXJ550R</p> <p style="text-align: center;">Area suffix</p> <p>B ----- U.K. E ----- Continental Europe EN ----- Northern Europe EV ----- Eastern Europe</p>	<p style="text-align: center;">SP-MXJ550</p> <p style="text-align: center;">Area suffix</p> <p>B ----- U.K. E ----- Continental Europe EN ----- Northern Europe EV ----- Eastern Europe</p>
<p style="text-align: center;">CA-MXJ552R</p> <p style="text-align: center;">Area suffix</p> <p>E ----- Continental Europe EN ----- Northern Europe</p>	<p style="text-align: center;">SP-MXJ550/SP-MXJ552</p> <p style="text-align: center;">Area suffix</p> <p>E ----- Continental Europe EN ----- Northern Europe</p>

- Contents -

Exploded view of general assembly and parts list	3-3
CD changer mechanism assembly and parts list	3-6
CD mechanism assembly and parts list	3-8
Cassette mechanism assembly and parts list	3-9
Electrical parts list	3-14
Packing materials and accessories parts list	3-26

MX-J550R
MX-J552R

-MEMO-

Exploded view of general assembly and parts list

Block No. **M 1 M M**

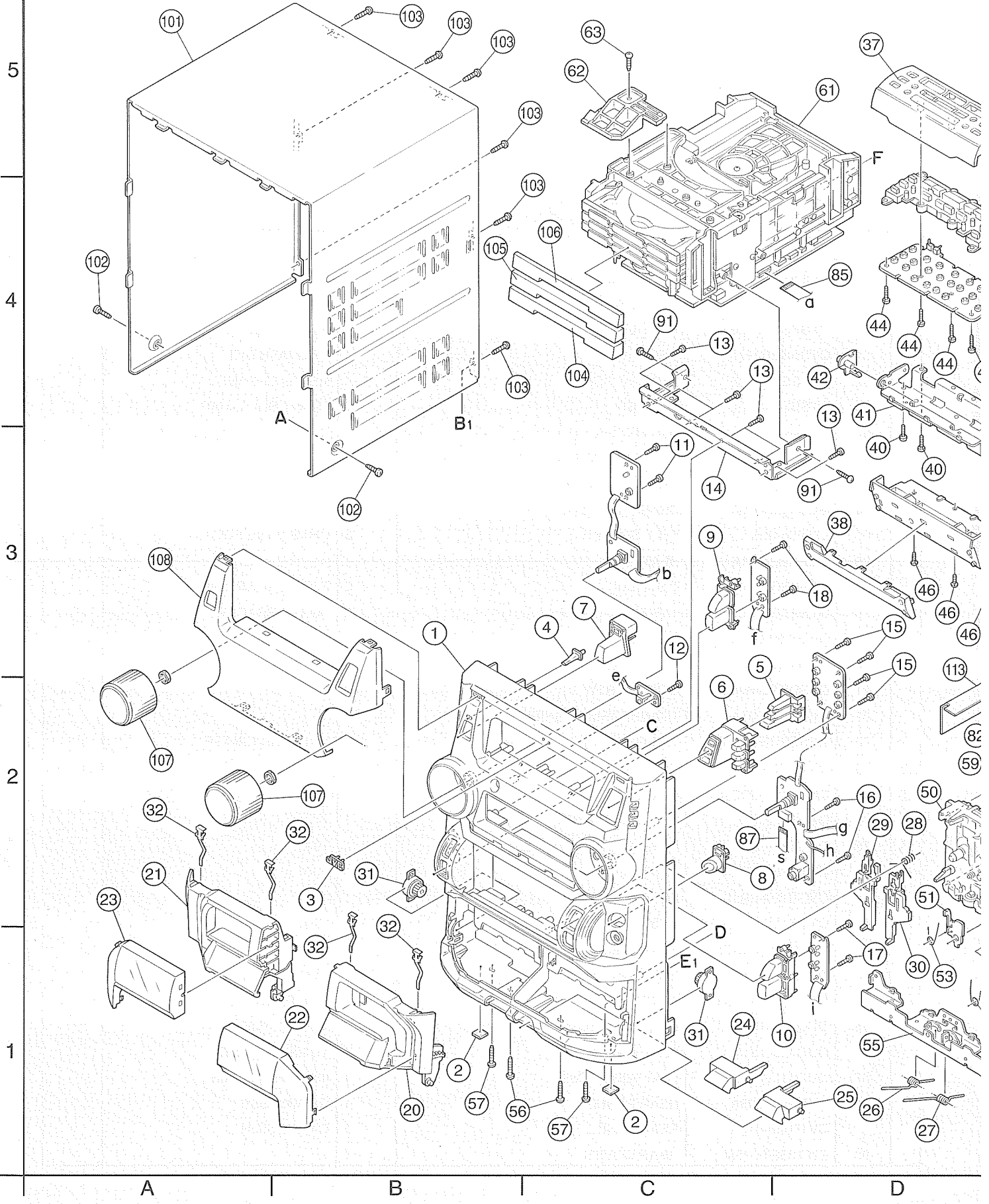

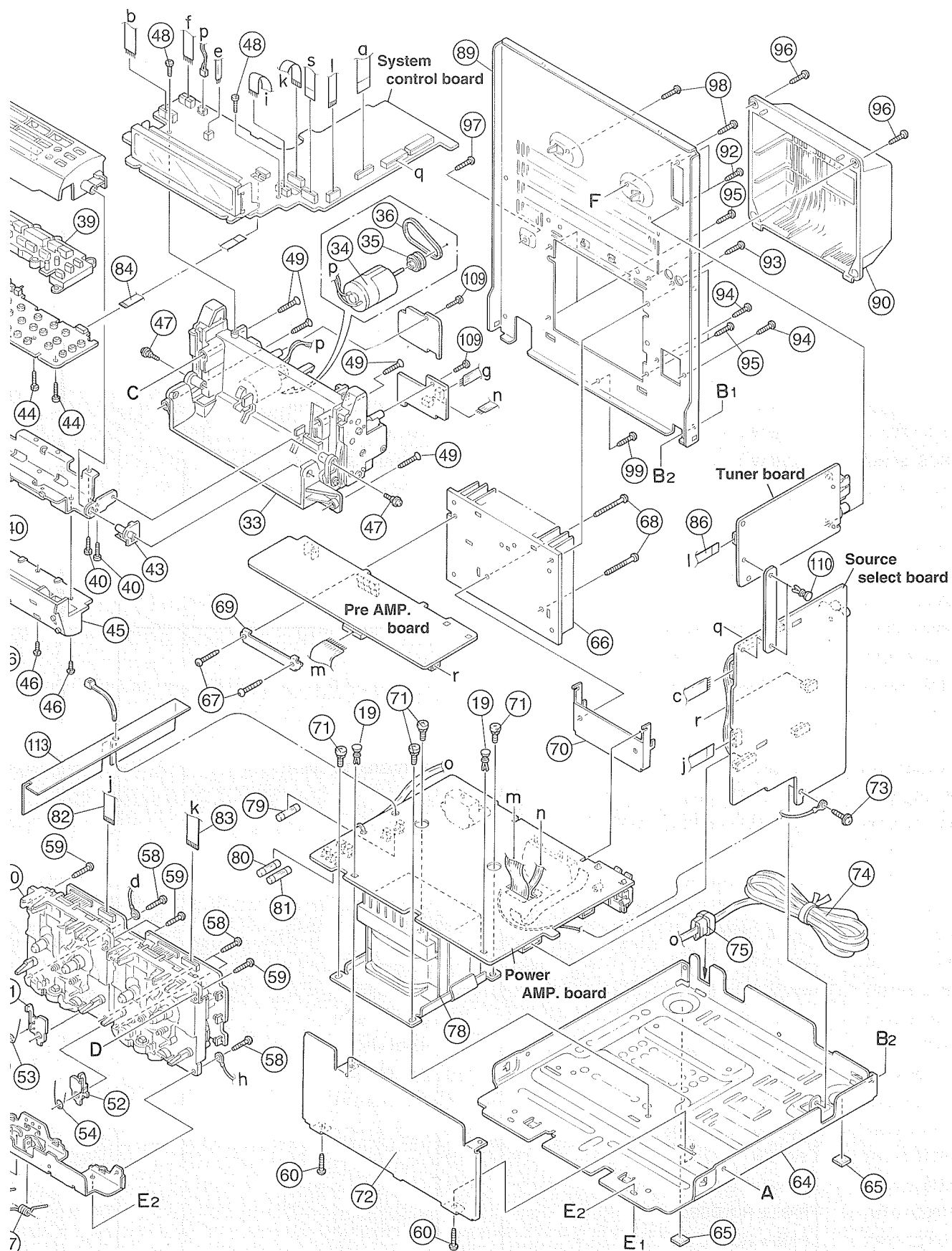

■ Parts list (General assembly)

Block No. M1

△	Item	Parts Number	Parts Name	Q'ty	Description	Area
	1	GV10027-003A	FRONT PANEL	1		
	2	E75896-001	FELT SPACER	2		
	3	GV40077-001A	JVC BADGE	1		
	4	GV40080-001A	STANDBY INDICATOR	1		
	5	GV20056-001A	CD EJECT BUTTON	1		
	6	GV20057-001A	CD BUTTON	1		
	7	GV30087-001A	POWER BUTTON	1		
	8	GV30088-001A	PUSH BUTTON	1		
	9	GV20049-003A	SOURCE BUTTON(A)	1	CD/TAPE	
	10	GV20050-002A	SOURCE BUTTON(B)	1	TUNER/AUX	
	11	QYSDSF2608Z	SCREW	2	POWER BOARD	
	12	QYSDSF2608Z	SCREW	1	REMOTE SEN.BOARD	
	13	QYSDSF2608Z	SCREW	6	STY.BKT+F.PANEL	
	14	GV30082-001A	STAY BRACKET	1		
	15	QYSDSF2608Z	SCREW	4	CD SWITCH BOARD	
	16	QYSDSF2608Z	SCREW	2	VOLUME BOARD	
	17	QYSDSF2608Z	SCREW	2	CD/TAPE S.BOARD	
	18	QYSDSF2608Z	SCREW	2	TUNER/AUX S.BOA	
	19	FMYH4004-001	PLASTIC RIVET	2	TRANS SHD/P.BOA	
	20	GV10029-001A	CASSETTE HOLDER(L)	1		
	21	GV10030-001A	CASSETTE HOLDER(R)	1		
	22	GV20053-001A	CASSETTE LENS(L)	1		
	23	GV20054-001A	CASSETTE LENS(R)	1		
	24	GV30077-001A	EJECT BUTTON(A)	1		
	25	GV30078-001A	EJECT BUTTON(B)	1		
	26	FMKW4009-001	HOLDER SPRING(A)	1		
	27	FMKW4010-001	HOLDER SPRING(B)	1		
	28	FMKW4011-001	SPRING	1	FOR EJECT LEVER	
	29	FMKS3002-003	EJECT LEVER(A)	1		
	30	FMKS3003-003	EJECT LEVER(B)	1		
	31	GV40034-001A	DAMPER ASS'Y	2		
	32	VKY4180-401	CASSETTE SPRING	4		
	33	GV10014-004A	CASE ASS'Y	1		
	34	MXN-13FB12F	DC MOTOR	1		
	35	GV40022-001A	MOTOR PULLEY	1		
	36	GV30038-001A	CAPSTAN BELT	1		
	37	GV30086-004A	MOVING PANEL(A)	1	CA-MXJ550R	
		GV30086-006A	MOVING PANEL(A)	1	CA-MXJ552R	
	38	GV30089-001A	PANEL PLATE	1	CA-MXJ550R	
		GV30089-002A	PANEL PLATE	1	CA-MXJ552R	
	39	GV20058-002A	CONTROL BUTTON	1		
	40	QYSDSF2608Z	SCREW	4		
	41	GV30042-002A	PANEL BRACKET	1		
	42	GV40028-001A	PANEL HOLDER(L)	1		
	43	GV40028-002A	PANEL HOLDER(R)	1		
	44	QYSDSF2608Z	SCREW	4		

■ Parts list (General assembly)

Block No. M1

△	Item	Parts Number	Parts Name	Q'ty	Description	Area
	45	GV20059-001A	MOVING PANEL(B)	1	CA-MXJ550R	
		GV20059-003A	MOVING PANEL(B)	1	CA-MXJ552R	
	46	QYSBST2606Z	T.SCREW	3	M.PNL B/PNL BKT	
	47	VKZ4341-204	SPECIAL SCREW	2	ARM CASE/PNL BK	
	48	QYSDSF2608Z	SCREW	2	FL BRD./CASE AS	
	49	QYSSSF3012Z	TAP SCREW	4	MOVING PNL/F.PANEL	
	50	-----	CASSETTE MECHA	1		
	51	FMKL4012-004	EJECT SAFETY(A)	1		
	52	FMKL4013-001	EJECT SAFETY(B)	1		
	53	FMKW4007-001	SPRING(A)	1	EJECT SAFETY(A)	
	54	FMKW4008-001	SPRING(B)	1	EJECT SAFETY(B)	
	55	GV20055-001A	HOLDER BRACKET	1		
	56	QYSBSG3010E	T.SCREW	2	F.P.TO H.BKT.	
	57	QYSBSG3010E	T.SCREW	2	F.P.TO CHS.BASE	
	58	QYSBSG3010Z	T.SCREW	4	MECHA&H.BKT.	
	59	QYSBSF3012Z	TAPPING SCREW	4	MECHA&F.PANEL	
	60	QYSBSG3010E	T.SCREW	2	TRANS SHD/C.BAS	
	61	-----	3CD MECHA	1		
	62	E309662-001SM	DISC STOPPER	1		
	63	QYSBSF3008Z	TAPPING SCREW	1	DISC STOPPER	
	64	GV10025-001A	CHASSIS BASE	1		
	65	E75896-006	FELT SPACER	2	CHAS.BASE FOOT	
	66	GV30083-001A	HEAT SINK	1		
	67	QYSBSG3014E	T.SCREW	2	FOR LEAF SPRING	
	68	QYSBSG3020E	TAPPING SCREW	2	FOR IC BRACKET	
	69	GV40029-001A	LEAF SPRING	1		
	70	GV30080-001A	IC BRACKET	1		
	71	QYSDSTL4008Z	ASS'Y SCREW	4		
	72	GV30079-001A	TRANSFORMER SHIELD	1		
	73	QYSBSGG3008E	T.SCREW	1	MAIN/BRD/C.BASE	
△	74	QMPK090-205-JN	POWER CORD	1		E,EN,EV
△		QMPN090-200-JC	POWER CORD	1		B
	75	QZW0033-001	CORD STOPPER	1		
△	78	QQT0276-002	POWER TRANSFORMER	1	T001	
△	79	QMF51E2-1R6-J1	FUSE	1	F001	
△	80	QMF51E2-3R15-J1	FUSE	1	F101	
△	81	QMF51E2-3R15-J1	FUSE	1	F102	
	82	QUQ412-1028CJ	FLAT WIRE(FC315)	1	SLC TO FMC	
	83	QUQ412-1118DJ	FLAT WIRE(FC869)	1	SLC TO FMB	
	84	QUQ110-0915BJ	FLAT WIRE(FC879)	1	ROL.P TO FMB	
	85	QUQ110-1908BJ	FLAT WIRE(FC868)	1	VC3 TO FMB	
	86	QUQ412-1317CJ	FLAT WIRE(FC865)	1	TUNER TO FMB	
	87	QUQ412-1112DJ	FLAT WIRE(FC880)	1	MAIN VR TO FMB	
	89	GV10026-008A	REAR PANEL	1	CA-MXJ550R	
		GV10026-010A	REAR PANEL	1	CA-MXJ552R	
	90	E207356-002SM	REAR COVER	1		

■ Parts list (General assembly)

Block No. M1

△	Item	Parts Number	Parts Name	Q'ty	Description	Area
	91	QYSBSF3010Z	T.SCREW	2	VC3/STAY BRACKET	
	92	QYSBSGY3008E	TAPPING SCREW	2	ANTENNA/R.PANEL	
	93	QYSBSGY3008E	TAPPING SCREW	1	AUX.TEM/P.PANEL	
	94	QYSBSGY3008E	TAPPING SCREW	2	SPK TEM/R.PANEL	
	95	QYSBSGY3008E	TAPPING SCREW	4	H.SINK/R.PANEL	
	96	QYSBSGY3008E	TAPPING SCREW	2	R.COVER/R.PANEL	
	97	QYSBSGY3008E	TAPPING SCREW	1	GROUND/R.PANEL	
	98	QYSBSGY3008E	TAPPING SCREW	2	VC3/REAR PANEL	
	99	QYSBSGY3008E	TAPPING SCREW	1	R.PANEL/C.BASE	
	101	GV10024-001A/S/	METAL COVER	1		
	102	QYSDSG3006M	TAPPING SCREW	2	M.COVER+C.BASE	
	103	QYSBSGY3008E	TAPPING SCREW	6	M.COVER+R.PANEL	
	104	GV30074-001A	CD FITTING(DISC1)	1	CA-MXJ550R	
		GV30074-002A	CD FITTING(DISC1)	1	CA-MXJ552R	
	105	GV30075-001A	CD FITTING(DISC2)	1	CA-MXJ550R	
		GV30075-002A	CD FITTING(DISC2)	1	CA-MXJ552R	
	106	GV30076-001A	CD FITTING(DISC3)	1	CA-MXJ550R	
		GV30076-002A	CD FITTING(DISC3)	1	CA-MXJ552R	
	107	GV30084-001A	VOLUME KNOB	2	SA BASS&VOLUME	
	108	GV10028-003A	WINDOW SCREEN	1	CA-MXJ550R	
		GV10028-004A	WINDOW SCREEN	1	CA-MXJ552R	
	109	QYSDSF2608Z	SCREW	2	WIRE&MOTOR STOP	
	110	FMYH4004-001	PLASTIC RIVET	2		
	113	GV30104-001A	PROTECT SHEET	1		

MX-J550R
MX-J552R

CD changer mechanism assembly and parts list

VC3-21M

Block No. M 2 M M

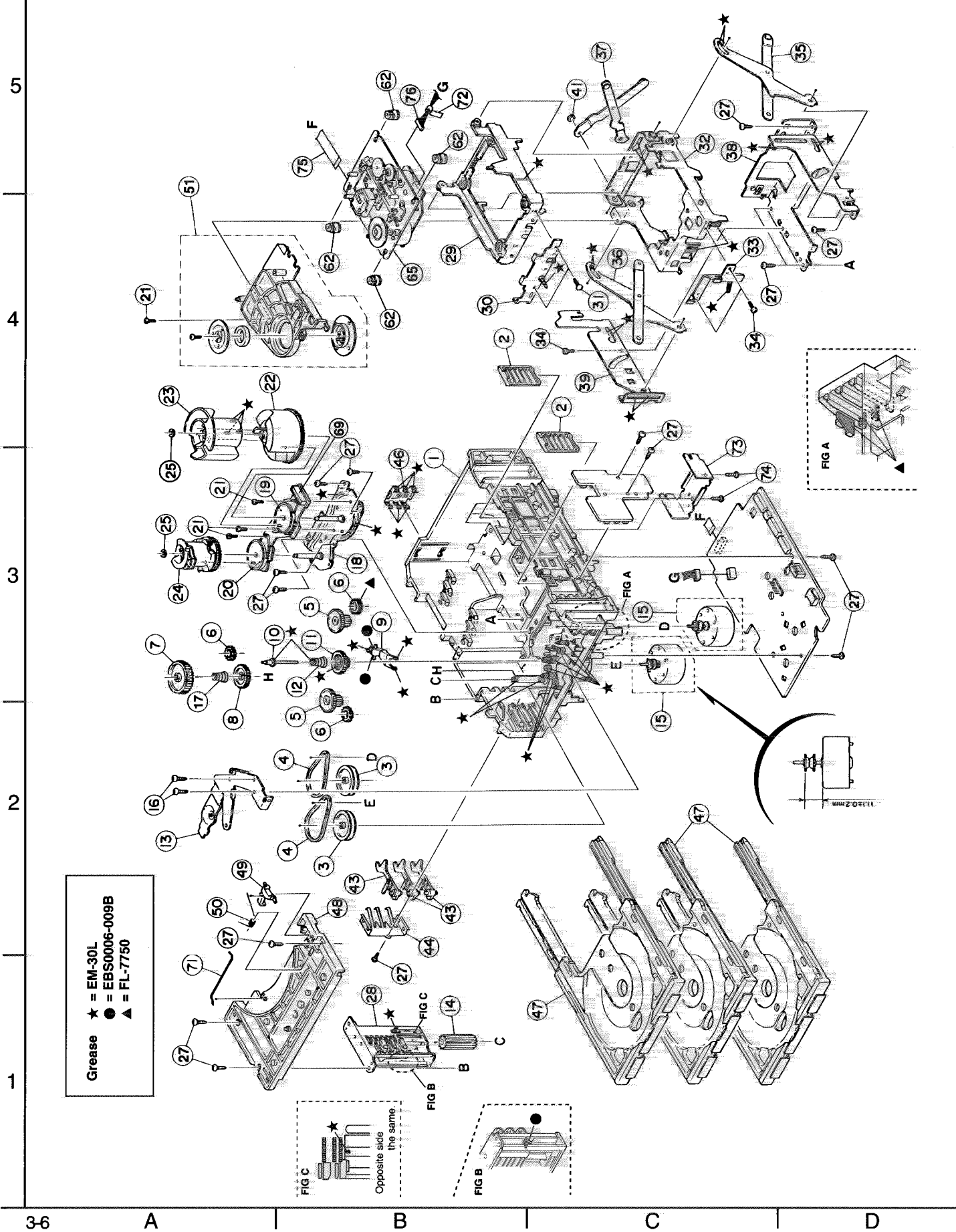

Grease
 ★ = EM-30L
 ● = EBS0006-009B
 ▲ = FL-7750

FIG C
 Opposite side
 the same

FIG B

FIG A

11±0.2mm

■ Parts list (CD changer mechanism)

Block No. M2MM

△	Item	Parts number	Parts name	Q'ty	Description	Area
	1	VKS1144-003	CHASSIS	1		
	2	VKS3698-003	TRAY GUIDE	2		
	3	VKS5532-003	PULLEY GEAR	2		
	4	VKB3000-164	BELT	2		
	5	VKS5505-003	GEAR B	2		
	6	VKS5506-002	GEAR C	3		
	7	VKS5507-002	CROSS GEAR U	1		
	8	VKS5508-002	CROSS GEAR L	1		
	9	VKS5510-003	SELECT LEVER	1		
	10	VKH5769-001	S.G.SHAFT	1		
	11	VKS5511-002	SELECT GEAR	1		
	12	VKW5155-003	COMP.SPRING	1	FOR SELECT GEAR	
	13	VKM3846-002	GEAR BRACKET	1		
	14	VKS5509-002MM	CYLINDER GEAR	1		
	15	MSN5D257A-SA2	D.C.MOTOR ASS'Y	2		
	16	QYSPSPD2616Z	SCREW	2	FOR MOTOR	
	17	LV40612-001A	COMP.SPRING	1		
	18	VKM3825-00AMM	C.G.BASE ASS'Y	1		
	19	VKZ3172-00ASS	CAM SW. R ASS'Y	1		
	20	VKZ3173-00ASS	CAM SW. L ASS'Y	1		
	21	QYSPST2606Z	SCREW	4		
	22	VKS2263-002MM	CAM R1	1		
	23	VKS2264-002MM	CAM R2	1		
	24	VKS2265-002MM	CAM GEAR L	1		
	25	WDL316050MM	SLIT WASHER	2		
	27	QYSBSF2608Z	T.SCREW	16		
	28	VKS3702-00FMM	DRIVE UNIT	1		
	29	VKS2247-004	MECHA HOLDER A	1		
	30	VKL7767-00B	BRACKET ASS'Y	1		
	31	QYSBSF2606Z	SCREW	2	FOR BRACKET	
	32	VKM3860-00A	M.HOLDER B ASS'Y	1		
	33	VKL7802-00C	M.HOLDER C ASS'Y	1		
	34	QYSDST2604Z	SCREW	3		
	35	VKL7810-00A	LIFTER ASS'Y R	1		
	36	VKL7811-00A	LIFTER ASS'Y L	1		
	37	VKL7812-00A	LIFTER ASS'Y H	1		
	38	VKL2732-002	LIFTER BASE	1		
	39	VKM3857-001	LIFTER BRACKET	1		
	41	WDL266035-2	SLIT WASHER	1		
	43	VKS5514-002MM	LOCK LEVER	3		
	44	VKY3133-002MM	RETURN SPRING	1		
	46	VKY3134-003MM	CLICK SPRING	1		
	47	VKS2252-00E	TRAY ASS'Y	3		
	48	VKS2250-003	TOP BRACKET	1		
	49	VKS5515-002	S.TRAY STOPPER	1		
	50	VKW5156-004	TORSION SPRING	1		
	51	VKS3703-00G	CLAMPER ASS'Y	1		
	62	LV40761-003A	INSULATOR	4		
	65	-----	CD MECHA	1		
	69	QGB2012J1-10	CONNECTOR	1		
	71	VKW5187-001	ROD	1		
	72	VYSA1R2-033	SPACER	1	FOR EWS176-008	
	73	LE30611-001A	C.B.HOLDER	1	FOR CD CB	
	74	QYSBSF3008Z	SCREW	2	FOR HOLDER	
	75	QUQ610-1509AJ	CARD WIRE	1	TRAVERSE 15	
	76	EWS176-008	FLAT WIRE	1	TRAVERSE 6	

MX-J550R
MX-J552R

CD mechanism assembly and parts list

Block No. **M 3 M M**

Grease Point
FG-87HS
(Grease to apply have to be a little for the exchange.)

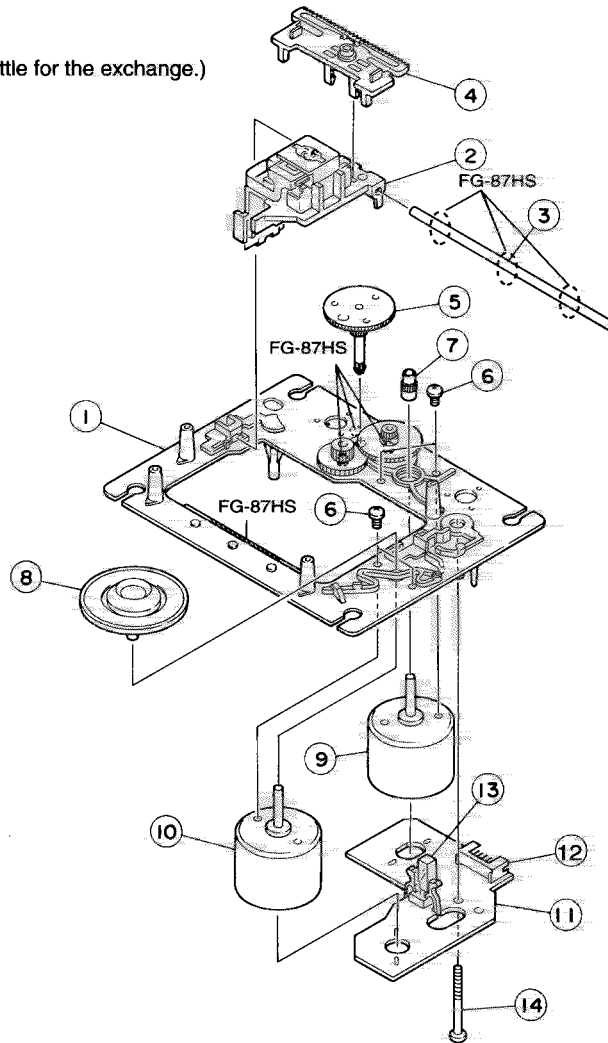

EXL-M7TMB
EXL-M7MB

Parts list (CD mechanism)

Block No. **M 3 M M**

Item	Parts number	Parts name	Q'ty	Description	Area
1	E102731-221SM	MECHA BASE	1		
2	OPTIMA-7B	OPTICAL PICK UP	1		
3	E406777-002SM	CD SHAFT	1		
4	LV31002-001A	CD RACK	1		
5	E307745-441SM	MECHA GEAR	1		
6	QYSDSP2003N	SCREW	4		
7	E406750-442SM	PINION GEAR	1		
8	EPB-001PK	TURN TABLE	1	SINGLE CD	
	EPB309173PKA	TURN TABLE	1	CHANGER CD	
9	E406784-001	FEED MOTOR	1		
10	QAR0130-001	SPPINDLE MOTOR	1		
11	EMW10190-441	P.C.BOARD	1		
12	QGA2001F1-06	6P PLUG ASSY	1		
13	QSW0506-001	LEAF SWITCH	1		
14	E75832-221SS	SPECIAL SCREW	1		

Cassette mechanism assembly and parts list

Block No. **M 4 M M**

SLC-W6M

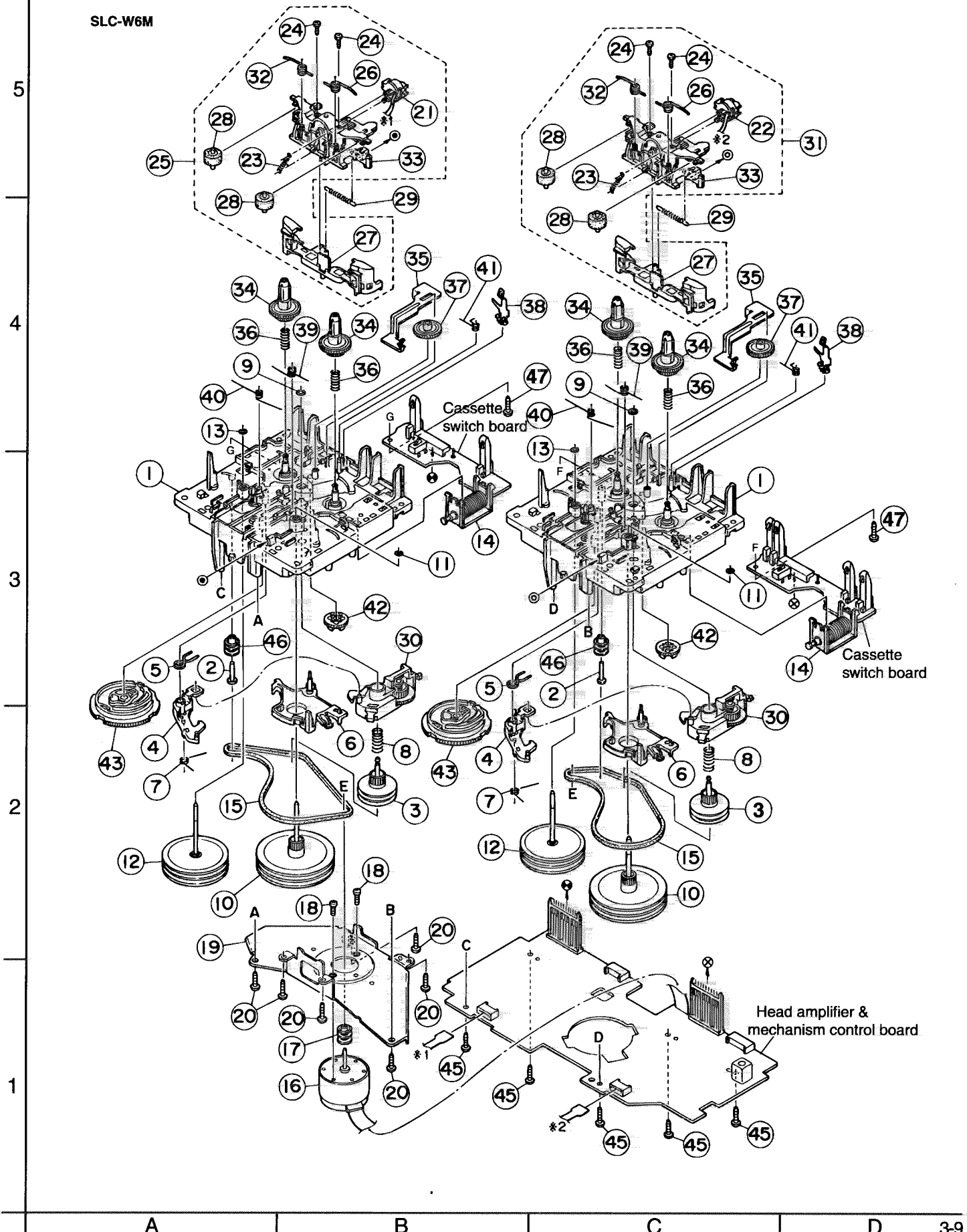

MX-J550R
MX-J552R

■ Parts list (Cassette mechanism)

Block No. M4MM

△	Item	Parts number	Parts name	Q'ty	Description	Area
	1	VKS1165-00H	CHASSIS B.ASS'Y	2		
	2	VKH5786-002	SHAFT	2		
	3	VKS5603-00D	MAIN PULLEY ASY	2		
	4	VKS3785-001MM	FR ARM	2		
	5	VKW5284-002	SWING SPRING	2		
	6	VKS2278-003	TRIGGER ARM	2		
	7	VKW5301-001	FR SPRING	2		
	8	VKW5266-001	ELEVATOR SPRING	2		
	9	WDL214025	WASHER	2		
	10	VKF3205-00B	F.WHEEL ASSY(R)	2		
	11	WDL183425	SLIT WASHER	2		
	12	VKF3207-00B	F.WHEEL ASSY(L)	2		
	13	WDL173525-6	SLIT WASHER	2		
	14	VKZ3174-00A	DC SOLENOID	2		
	15	VKB3000-182	CAPSTAN BELT(B)	2		
	16	MSI-5U2LWA	D.C.MOTOR ASS'Y	1		
	17	VKR4761-001	MOTOR PULLEY	1		
	18	QYSPSP2604Z	SCREW	2		
	19	VKM3907-001	JOINT BRACKET	1		
	20	QYSBSF2608Z	T.SCREW	6		
	21	LV41090-001A	P.B.HEAD	1		
	22	LV41089-001A	R/P&E HEAD	1		
	23	VKW5302-001	HEAD SPRING	2		
	24	VKZ4730-001	SPECIAL SCREW	4		
	25	VKS2279-00D	HEAD MOUNT ASSY	1		
	26	VKW5299-002	PIN ROL.SP.(R)	2		
	27	VKS2277-005	DIRECTION LEVER	2		
	28	VKP4233-00A	PINCH ROL. ASSY	4		
	29	VKW5285-001	RETURN SPRING	2		
	30	VKS3786-00G	CLUTCH ASS'Y	2		
	31	VKS2275-00D	HEAD MOUNT ASSY	1		
	32	VKW5300-002	PIN ROL.SP.(L)	2		
	33	VKS1167-001	HEAD MOUNT BASE	2		
	34	VKS2274-002	REEL GEAR	4		
	35	VKM3906-003	PLAY SW LEVER	2		
	36	VKW5286-002	B.T. SPRING	4		
	37	VKS5559-001	PLAY IDLE GEAR	2		
	38	VKY3149-002	CASSETTE SP.	2		
	39	VKW5279-001	HEAD BASE SP(R)	2		
	40	VKW5280-001	HEAD BASE SP(L)	2		
	41	VKW5296-001	EARTH SPRING	2		
	42	VKS5597-00A	BLIND	2		
	43	VKS1166-003	CONTROL CAM	2		
	45	QYSBSF2608Z	T.SCREW	5	FOR P.W.B.	
	46	VKR4749-002	IDLE PULLEY	2		
	47	QYSBSF2006Z	SCREW	2		

Grease point

Grease	
★	=JC-525
■	=FL-7750
▲	=UD-24
△	=UD-24H2
●	=LX-1349B
◎	=MOBIL-1

5

4

Should be applied to the rack of dir. lever fully.

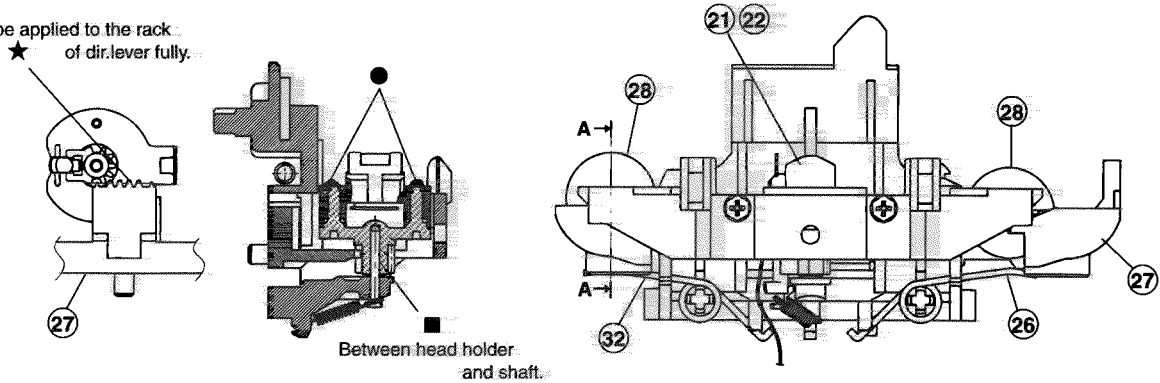

Between head holder and shaft.

3

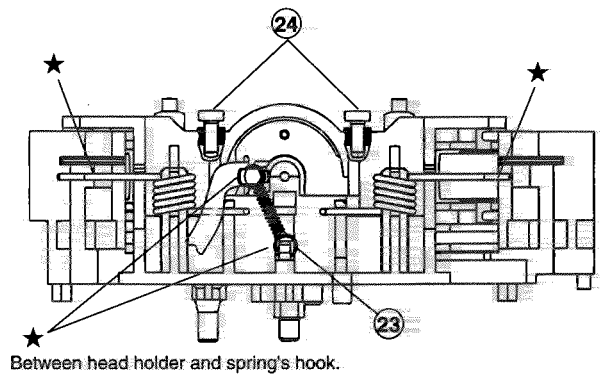

Between head holder and spring's hook.

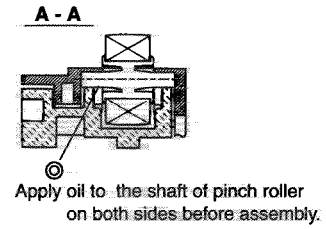

Apply oil to the shaft of pinch roller on both sides before assembly.

2

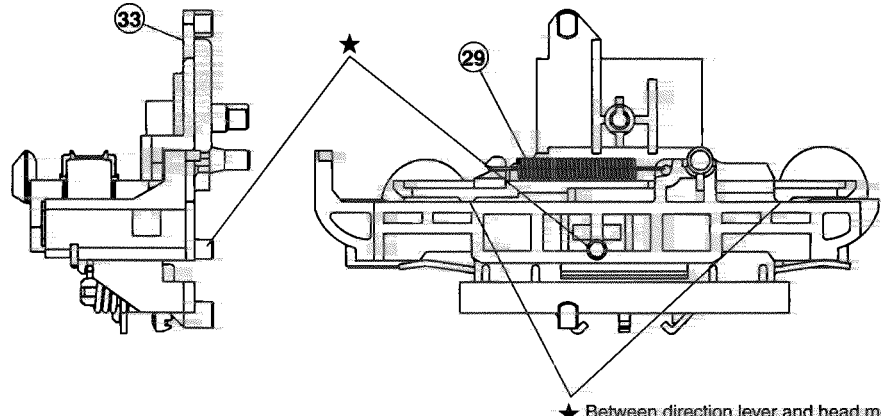

★ Between direction lever and head mount base.

1

MX-J550R
MX-J552R

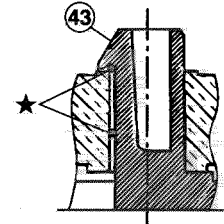
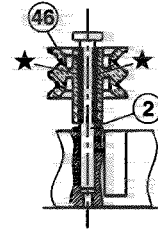
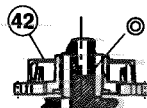
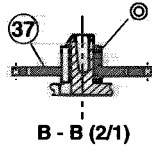
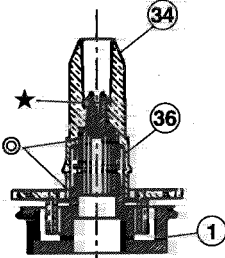
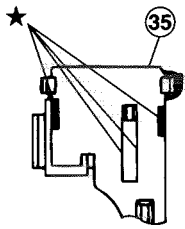
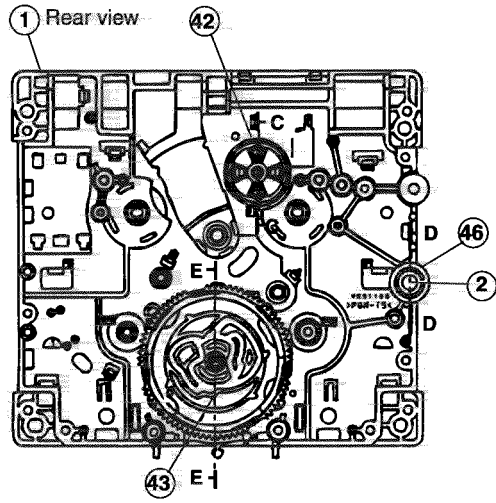
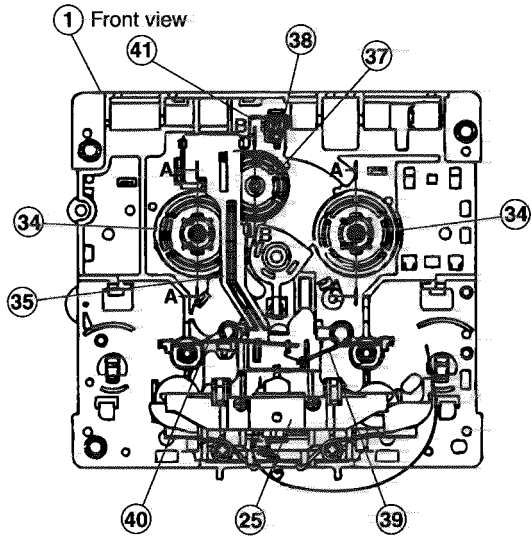

A - A (2/1, 2 places)

C - C (2/1)

D - D (2/1)

E - E (5/1)

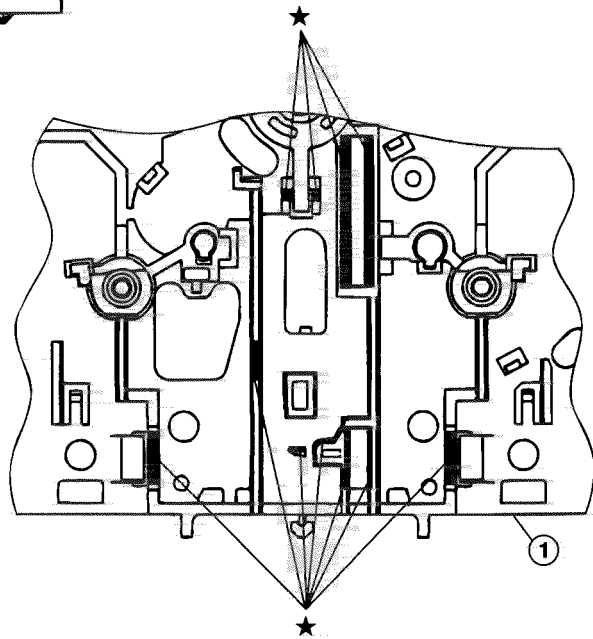
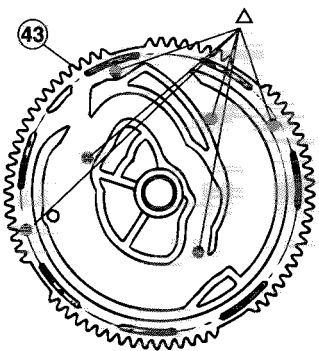
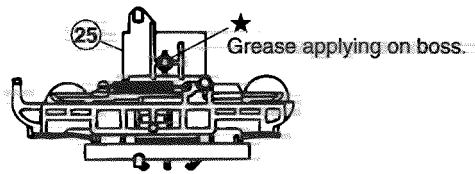
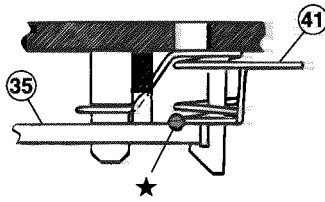

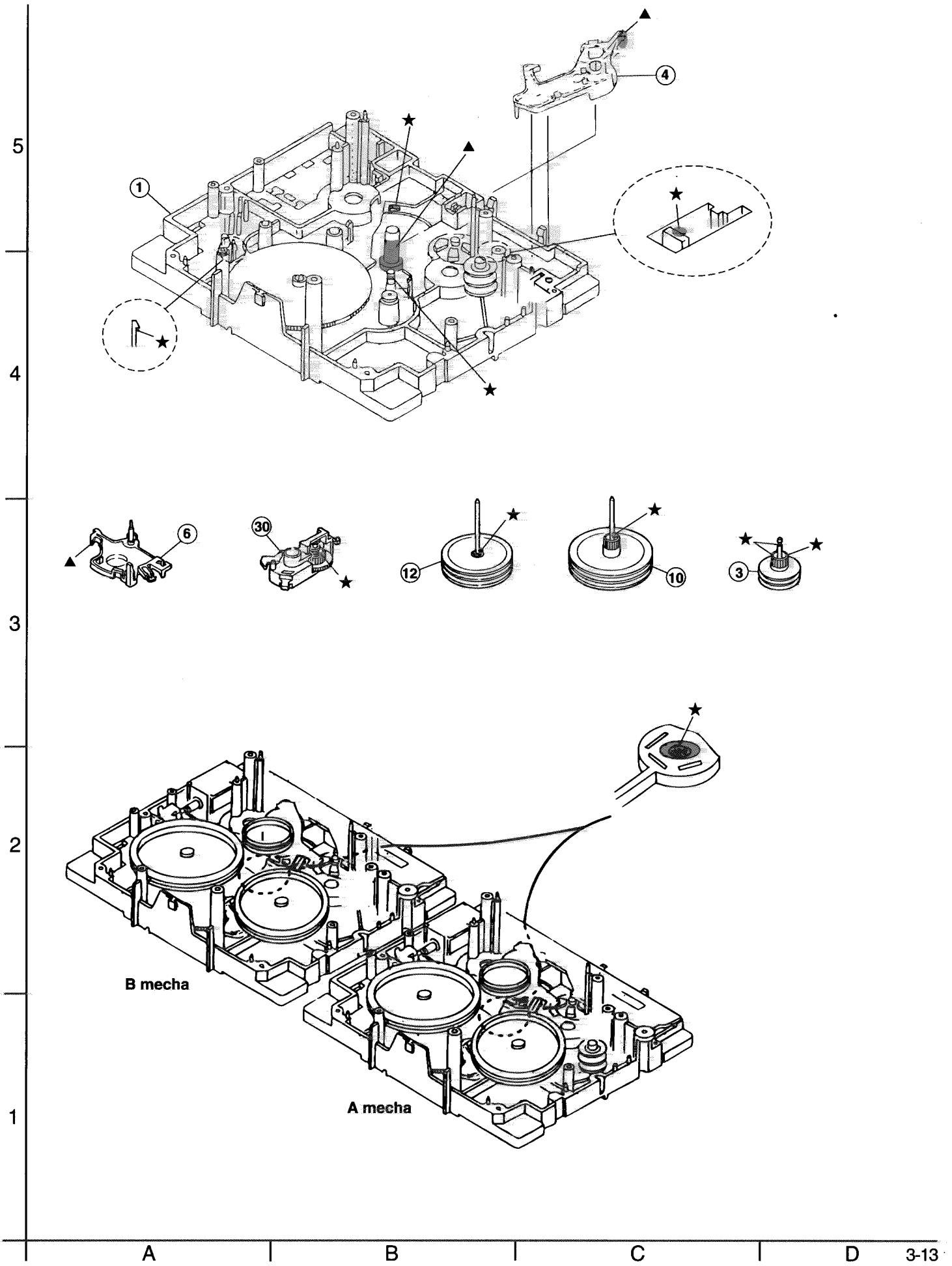

MX-J550R
MX-J552R

■ Electrical Parts List (Power AMP. & Source select board) Block No. 01

Block No	Item	Part Number	Description	Area	Block No	Item	Part Number	Description	Area	
I.C.S.	IC436	TDA7439	I.C.(M)		C203	QFV82AJ-104	0.1MF 100V THIN FILM CA			
	IC526	BA15218	I.C.(MONO-ANALOG)		C204	QEZ0469-478	4700MF AL E.CAPACIT			
DIODES	IC701	STK412-000	I.C.(HYBRID)		C205	QEZ0469-478	4700MF AL E.CAPACIT			
	D201	1N5402M-20	DIODE		C211	QFVJ1HJ-104Z	0.1MF 50V TF CAPACITOR			
	D202	1N5402M-20	DIODE		C212	QFVJ1HJ-104Z	0.1MF 50V TF CAPACITOR			
	D203	1N5402M-20	DIODE		C213	QFVJ1HJ-104Z	0.1MF 50V TF CAPACITOR			
	D204	1N5402M-20	DIODE		C214	EETB1VM-228JC	2200MF 35V AL E.CAPACIT			
	D211	30DF2-FC	SI.DIODE		C215	EETB1VM-228JC	2200MF 35V AL E.CAPACIT			
	D212	30DF2-FC	SI.DIODE		C216	QETN1VM-107Z	100MF 35V E.CAPACITOR			
	D213	30DF2-FC	SI.DIODE		C217	QETN1JM-476Z	47MF 63V E.CAPACITOR			
	D214	30DF2-FC	SI.DIODE		C218	EETC1HM-226ZJ	22MF 50V E.CAPACITOR			
	D217	1N4003S-T5	SI.DIODE		C219	QDYB1CM-103Y	0.01MF 16V CER.CAPACITO			
	D218	1N4003S-T5	SI.DIODE		C220	EETC1HM-226ZJ	22MF 50V E.CAPACITOR			
	D219	MTZJ33C-T2	Z DIODE		C221	EETB1HM-475E	4.7MF 50V E.CAPACITOR			
	D220	MTZJ9.1B-T2	ZENER DIODE		C222	EETB1HM-475E	4.7MF 50V E.CAPACITOR			
	D221	MTZJ5.1B-T2	ZENER DIODE		C223	EETC1HM-226ZJ	22MF 50V E.CAPACITOR			
	D223	1SS133-T2	SI.DIODE		C233	QFLM1HJ-103Z	0.01MF 50V M.CAPACITOR			
	D227	1N4003S-T5	SI.DIODE		C401	QCBB1HK-221Y	220PF 50V CER.CAPACITO			
	D411	1SS133-T2	SI.DIODE		C402	QCBB1HK-221Y	220PF 50V CER.CAPACITO			
	D412	1SS133-T2	SI.DIODE		C403	QETC1AM-477ZM	470MF 10V C.CAPACITOR			
	D426	MTZJ5.1B-T2	ZENER DIODE		C404	QETN1CM-476Z	47MF 16V AL E.CAPACIT			
	D431	1SS133-T2	SI.DIODE		C411	QCBB1HK-221Y	220PF 50V CER.CAPACITO			
	D432	1SS133-T2	SI.DIODE		C412	QCBB1HK-221Y	220PF 50V CER.CAPACITO			
	D433	1SS133-T2	SI.DIODE		C415	QDXB1CM-222Y	2200PF 16V C.CAPACITOR			
	D434	MTZJ5.1B-T2	SI.DIODE		C426	QDVB1EZ-223Y	0.022MF 25V C.CAPACITO			
	D573	1SS133-T2	SI.DIODE		C427	EETB1EM-106E	10MF 25V E.CAPACITOR			
	D703	MTZJ15C-T2	Z DIODE		C432	QFLM1HJ-102Z	1000PF 50V MYLAR CAPACI			
	D704	MTZJ15C-T2	Z DIODE		C433	QFLM1HJ-103Z	0.01MF 50V MYLAR CAPACI			
	D719	1SS133-T2	SI.DIODE		C436	EETB1AM-107E	100MF 10V E.CAPACITOR			
	D720	1SS133-T2	SI.DIODE		C437	EETB1EM-106E	10MF 25V E.CAPACITOR			
D723	MTZJ33C-T2	Z DIODE		C438	QDYB1CM-103Y	0.01MF 16V CER.CAPACITO				
D724	MTZJ33C-T2	Z DIODE		C439	QETN1EM-106Z	10MF 25V E.CAPACITOR				
D725	1SS133-T2	SI.DIODE		C440	QETN1EM-106Z	10MF 25V E.CAPACITOR				
D728	1SS133-T2	SI.DIODE		C441	QTE1V06-106Z	AL E.CAPACIT				
D742	MTZJ2.4B-T2	Z DIODE		C442	QTE1V06-106Z	AL E.CAPACIT				
TRANSISTORS	Q201	KTA1023/OY-T	SI.TRANSISTOR		C443	QETN1HM-225Z	2.2MF 50V AL E.CAPACIT			
	Q203	KRC107M-T	DIGITAL TRANSISTOR		C444	QETN1HM-225Z	2.2MF 50V AL E.CAPACIT			
	Q204	KTC3199/GL-T	SI.TRANSISTOR		C445	QETN1EM-106Z	10MF 25V E.CAPACITOR			
	Q240	KTC3199/GL-T	SI.TRANSISTOR		C446	QETN1EM-106Z	10MF 25V E.CAPACITOR			
	Q401	2SC3576-JVC-T	SI.TRANSISTOR		C447	QTE1V06-106Z	AL E.CAPACIT			
	Q402	2SC3576-JVC-T	SI.TRANSISTOR		C448	QTE1V06-106Z	AL E.CAPACIT			
	Q483	KRA102M-T	DIGITAL TRANSISTOR		C449	QETN1HM-225Z	2.2MF 50V AL E.CAPACIT			
	Q561	2SC3576-JVC-T	SI.TRANSISTOR		C450	QETN1HM-225Z	2.2MF 50V AL E.CAPACIT			
	Q562	2SC3576-JVC-T	SI.TRANSISTOR		C453	QFVJ1HJ-154Z	0.15MF 50V TF CAPACITOR			
	Q571	2SC2785/FE-T	TRANSISTOR		C454	QFVJ1HJ-154Z	0.15MF 50V TF CAPACITOR			
	Q572	2SC2785/FE-T	TRANSISTOR		C455	QFVJ1HJ-274Z	0.27MF 50V CAPACITOR			
	Q573	2SC2785/FE-T	TRANSISTOR		C456	QFVJ1HJ-274Z	0.27MF 50V CAPACITOR			
	Q574	2SC2785/FE-T	TRANSISTOR		C457	QFLM1HJ-223Z	0.022MF 50V M.CAPACITOR			
	Q575	2SC2785/FE-T	TRANSISTOR		C458	QFLM1HJ-223Z	0.022MF 50V M.CAPACITOR			
	Q576	2SC2785/FE-T	TRANSISTOR		C459	QFLM1HJ-183Z	0.018MF 50V M.CAPACITOR			
	Q577	KRC111M-T	SI.TRANSISTOR		C460	QFLM1HJ-183Z	0.018MF 50V M.CAPACITOR			
	Q578	KRC111M-T	SI.TRANSISTOR		C461	QFLM1HJ-562Z	5600PF 50V MYLAR CAPACI			
	Q579	KRC111M-T	SI.TRANSISTOR		C462	QFLM1HJ-562Z	5600PF 50V MYLAR CAPACI			
	Q580	KRC111M-T	SI.TRANSISTOR		C488	EETB1HM-475E	4.7MF 50V E.CAPACITOR			
	Q581	KRC111M-T	SI.TRANSISTOR		C526	EETB1AM-107E	100MF 10V E.CAPACITOR			
	Q582	KRC111M-T	SI.TRANSISTOR		C527	QFVJ1HJ-104Z	0.1MF 50V TF CAPACITOR			
	Q701	KTA1268/GL-T	TRANSISTOR		C528	QFVJ1HJ-104Z	0.1MF 50V TF CAPACITOR			
	Q702	KTA1268/GL-T	TRANSISTOR		C529	QFVJ1HJ-104Z	0.1MF 50V TF CAPACITOR			
	Q710	KTA1268/GL-T	D.TRANSISTOR		C530	QFVJ1HJ-104Z	0.1MF 50V TF CAPACITOR			
	Q711	KTC3200/GL-T	TRANSISTOR		C531	QTE1C06-476Z	AL E.CAPACIT			
	Q712	KTA1268/GL-T	TRANSISTOR		C532	QTE1C06-476Z	AL E.CAPACIT			
	Q713	KTC3200/GL-T	D.TRANSISTOR		C535	EETB1AM-107E	100MF 10V E.CAPACITOR			
	Q726	2SC2389S/SE-T	SI.TRANSISTOR		C579	QETN1HM-474Z	0.47MF 50V AL E.CAPACIT			
	Q727	KTA1268/GL-T	TRANSISTOR		C580	QFVJ1HJ-184Z	0.18MF 50V M.CAPACITOR			
	Q728	KTC3199/GL-T	SI.TRANSISTOR		C581	EETB1HM-105E	1MF 50V E.CAPACITOR			
	Q733	2SC3576-JVC-T	SI.TRANSISTOR		C703	QCBB1HK-471Y	470PF 50V CER.CAPACITO			
	Q734	2SC3576-JVC-T	SI.TRANSISTOR		C704	QCBB1HK-471Y	470PF 50V CER.CAPACITO			
	Q735	2SC3576-JVC-T	SI.TRANSISTOR		C705	QCSB1HJ-220Y	22PF 50V CER.CAPACITO			
	Q736	2SC3576-JVC-T	SI.TRANSISTOR		C706	QCSB1HJ-220Y	22PF 50V CER.CAPACITO			
	Q737	KRA111M-T	DIGITAL TRANSISTOR		C707	QETN1CM-476Z	47MF 18V AL E.CAPACIT			
	Q742	2SK301/PQ-T	F.E.T.		C708	QETN1CM-476Z	47MF 18V AL E.CAPACIT			
	CAPACITORS	C201	QFV82AJ-104	0.1MF 100V THIN FILM CA		C709	QCSB1HK-4R7Y	4.7PF 50V CER.CAPACITO		
		C202	QFV82AJ-104	0.1MF 100V THIN FILM CA		C710	QCSB1HK-4R7Y	4.7PF 50V CER.CAPACITO		

■ Electrical Parts List (Power AMP. & Source select board) Block No. 01

Block No	Item	Part Number	Description	Area	Block No	Item	Part Number	Description	Area	
CAPACITORS	C711	QETN1JM-476Z	47MF 63V E.CAPACITOR			R553	QRE141J-223Y	22K 1/4W C RESISTOR		
	C712	QETN1JM-476Z	47MF 63V E.CAPACITOR			R554	QRE141J-223Y	22K 1/4W C RESISTOR		
	C713	QFLM1HJ-473Z	0.047MF 50V M.CAPACITOR			R561	QRE141J-103Y	10K 1/4W CARBON RESIS		
	C714	QFLM1HJ-473Z	0.047MF 50V M.CAPACITOR			R562	QRE141J-103Y	10K 1/4W CARBON RESIS		
	C715	QFLM1HJ-473Z	0.047MF 50V M.CAPACITOR			R581	QRE141J-224Y	220K 1/4W C RESISTOR		
	C716	QFLM1HJ-473Z	0.047MF 50V M.CAPACITOR			R582	QRE141J-101Y	100 1/4W C RESISTOR		
	C721	QTE1V06-106Z	AL E.CAPACIT			R583	QRE141J-101Y	100 1/4W C RESISTOR		
	C722	QTE1V06-106Z	AL E.CAPACIT			R584	QRE141J-222Y	2.2K 1/4W C RESISTOR		
	C723	EETC1HM-226ZJ	22MF 50V E.CAPACITOR			R585	QRE141J-242Y	2.4K 1/4W C RESISTOR		
	C726	EETB1EM-106Z	10MF 25V E.CAPACITOR			R586	QRE141J-274Y	270K 1/4W C RESISTOR		
	C729	EETB1CM-476	47MF 16V E.CAPACITOR			R588	QRE141J-224Y	220K 1/4W C RESISTOR		
	C730	QCF31HZ-223Z	0.022MF 50V C CAPACITOR			R589	QRE141J-101Y	100 1/4W C RESISTOR		
	C731	QCF31HZ-223Z	0.022MF 50V C CAPACITOR			R590	QRE141J-101Y	100 1/4W C RESISTOR		
	C732	QDXB1CM-222Y	2200PF 16V C CAPACITOR			R593	QRE141J-243Y	24K 1/4W C RESISTOR		
	C733	QFLM1HJ-104Z	0.1MF 50V M.CAPACITOR			R594	QRE141J-243Y	24K 1/4W C RESISTOR		
	C734	QDXB1CM-222Y	2200PF 16V C CAPACITOR			R595	QRE141J-433Y	43K 1/4W C RESISTOR		
	C735	QFLM1HJ-104Z	0.1MF 50V M.CAPACITOR			R596	QRE141J-433Y	43K 1/4W C RESISTOR		
	C736	QFLM1HJ-393Z	0.039MF 50V M.CAPACITOR			R597	QRE141J-104Y	100K 1/4W C RESISTOR		
	C737	QFLM1HJ-393Z	0.039MF 50V M.CAPACITOR			R598	QRE141J-104Y	100K 1/4W C RESISTOR		
	C739	QFLM1HJ-473Z	0.047MF 50V M.CAPACITOR			R701	QRJ146J-470X	47 1/4W UNF.CARBON R		
	C742	QETC1HM-224Z	0.22MF 50V AL E.CAPACIT			R702	QRJ146J-470X	47 1/4W UNF.CARBON R		
	C743	QFLM1HJ-823Z	0.082MF 50V MYLAR CAPACI			R703	QRE141J-563Y	56K 1/4W C RESISTOR		
	RESISTORS	R202	QRZ9042-2R2X	2.2 FUSIBLE RESI			R704	QRE141J-563Y	56K 1/4W C RESISTOR	
		R203	QRE141J-302Y	30K 1/4W C RESISTOR			R705	QRJ146J-821X	820 1/4W CARBON RESIS	
		R204	QRE141J-223Y	22K 1/4W C RESISTOR			R706	QRJ146J-821X	820 1/4W CARBON RESIS	
		R205	QRE141J-104Y	100K 1/4W C RESISTOR			R707	QRE141J-563Y	56K 1/4W C RESISTOR	
		R206	QRE141J-562Y	5.6K 1/4W C RESISTOR			R708	QRE141J-563Y	56K 1/4W C RESISTOR	
		R207	QRE141J-103Y	10K 1/4W CARBON RESIS			R713	QRJ146J-100X	10 1/4W UNF.CARBON R	
		R209	QRE141J-103Y	10K 1/4W CARBON RESIS			R714	QRJ146J-100X	10 1/4W UNF.CARBON R	
		R215	QRE141J-473Y	47K 1/4W C RESISTOR			R715	QRJ146J-100X	10 1/4W UNF.CARBON R	
		R216	QRE141J-473Y	47K 1/4W C RESISTOR			R716	QRJ146J-100X	10 1/4W UNF.CARBON R	
		R233	QRK126J-470X	47 1/2W UNF.CARBON R			R717	QRE141J-102Y	1K 1/4W C RESISTOR	
		R234	QRK126J-470X	47 1/2W UNF.CARBON R			R718	QRE141J-102Y	1K 1/4W C RESISTOR	
		R242	QRE141J-103Y	10K 1/4W CARBON RESIS			R719	QRE141J-562Y	5.6K 1/4W C RESISTOR	
		R401	QRE141J-102Y	1K 1/4W C RESISTOR			R720	QRE141J-562Y	5.6K 1/4W C RESISTOR	
		R402	QRE141J-102Y	1K 1/4W C RESISTOR			R721	QRE141J-103Y	10K 1/4W CARBON RESIS	
		R403	QRE141J-472Y	4.7K 1/4W CARBON RESIS			R722	QRE141J-103Y	10K 1/4W CARBON RESIS	
		R404	QRE141J-472Y	4.7K 1/4W CARBON RESIS			R723	QRE141J-152Y	1.5K 1/4W CARBON RESIS	
		R405	QRE141J-222Y	2.2K 1/4W C RESISTOR			R724	QRE141J-152Y	1.5K 1/4W CARBON RESIS	
		R406	QRE141J-222Y	2.2K 1/4W C RESISTOR			R725	QRE141J-823Y	82K 1/4W C RESISTOR	
		R407	QRE141J-272Y	2.7K 1/4W C RESISTOR			R726	QRE141J-104Y	100K 1/4W C RESISTOR	
		R411	QRE141J-103Y	10K 1/4W CARBON RESIS			R727	QRE141J-104Y	100K 1/4W C RESISTOR	
		R412	QRE141J-103Y	10K 1/4W CARBON RESIS			R728	QRE141J-103Y	10K 1/4W CARBON RESIS	
R413		QRE141J-683Y	68K 1/4W C RESISTOR			R729	QRE141J-104Y	100K 1/4W C RESISTOR		
R414		QRE141J-683Y	68K 1/4W C RESISTOR			R730	QRE141J-103Y	10K 1/4W CARBON RESIS		
R426		QRE141J-391Y	390 1/4W C RESISTOR			R731	QRJ146J-4R7X	4.7 1/4W UNF.CARBON R		
R431		QRE141J-303Y	30K 1/4W C RESISTOR			R732	QRJ146J-4R7X	4.7 1/4W UNF.CARBON R		
R432		QRE141J-303Y	30K 1/4W C RESISTOR			R733	QRE141J-472Y	4.7K 1/4W CARBON RESIS		
R434		QRJ146J-4R7X	4.7 1/4W UNF.C RESI			R734	QRE141J-472Y	4.7K 1/4W CARBON RESIS		
R435		QRE141J-103Y	10K 1/4W CARBON RESIS			R735	QRE141J-472Y	4.7K 1/4W CARBON RESIS		
R436		QRE141J-103Y	10K 1/4W CARBON RESIS			R736	QRE141J-472Y	4.7K 1/4W CARBON RESIS		
R437		QRE141J-102Y	1K 1/4W C RESISTOR			R739	QRL01DJ-821X	820 1W OXIDE METAL		
R438		QRE141J-272Y	2.7K 1/4W C RESISTOR			R740	QRL01DJ-821X	820 1W OXIDE METAL		
R439		QRE141J-562Y	5.6K 1/4W C RESISTOR			R742	QRE141J-473Y	47K 1/4W C RESISTOR		
R440		QRE141J-562Y	5.6K 1/4W C RESISTOR			R743	QRE141J-153Y	15K 1/4W C RESISTOR		
R441		QRE141J-272Y	2.7K 1/4W C RESISTOR			R744	QRE141J-475Y	4.7M 1/4W C RESISTOR		
R442		QRE141J-103Y	10K 1/4W CARBON RESIS			R745	QRE141J-105Y	1M 1/4W C RESISTOR		
R443		QRE141J-104Y	100K 1/4W C RESISTOR			R746	QRE141J-392Y	3.9K 1/4W C RESISTOR		
R444		QRE141J-104Y	100K 1/4W C RESISTOR			R747	QRE141J-203Y	20K 1/4W C RESISTOR		
R496		QRE141J-102Y	1K 1/4W C RESISTOR			R748	QRE141J-103Y	10K 1/4W CARBON RESIS		
R497		QRE141J-103Y	10K 1/4W CARBON RESIS			R750	QRJ146J-470X	47 1/4W UNF.CARBON R		
R526		QRE141J-101Y	100 1/4W C RESISTOR			R753	QRZ0196-R22	0.22 1W NETWORK RESIS		
R527		QRE141J-222Y	2.2K 1/4W C RESISTOR			R754	QRZ0196-R22	0.22 1W NETWORK RESIS		
R528		QRE141J-222Y	2.2K 1/4W C RESISTOR			R761	QRE141J-102Y	1K 1/4W C RESISTOR		
R529		QRE141J-332Y	3.3K 1/4W C RESISTOR			R762	QRE141J-102Y	1K 1/4W C RESISTOR		
R530		QRE141J-332Y	3.3K 1/4W C RESISTOR			R766	QRE141J-333Y	33K 1/4W C RESISTOR		
R533		QRE141J-204Y	200K 1/4W C RESISTOR			R767	QRE141J-103Y	10K 1/4W CARBON RESIS		
R534		QRE141J-204Y	200K 1/4W C RESISTOR			R768	QRE141J-103Y	10K 1/4W CARBON RESIS		
R535		QRE141J-113Y	11K 1/4W C RESISTOR			R774	QRJ146J-100X	10 1/4W UNF.CARBON R		
R536		QRE141J-113Y	11K 1/4W C RESISTOR			R775	QRE141J-102Y	1K 1/4W C RESISTOR		
R537		QRE141J-101Y	100 1/4W C RESISTOR			R776	QRE141J-102Y	1K 1/4W C RESISTOR		
R551		QRE141J-102Y	1K 1/4W C RESISTOR			R777	QRE141J-103Y	10K 1/4W CARBON RESIS		
R552		QRE141J-102Y	1K 1/4W C RESISTOR			R778	QRE141J-103Y	10K 1/4W CARBON RESIS		

MX-J550R
MX-J552R

■ Electrical Parts List (Power AMP. & Source select board) Block No. 01

△	Block No	Item	Part Number	Description	Area
	RESISTORS	R784	QRE141J-823Y	82K 1/4W C RESISTOR	
		R785	QRE141J-823Y	82K 1/4W C RESISTOR	
		R786	QRE141J-103Y	10K 1/4W CARBON RESIS	
		R787	QRE141J-103Y	10K 1/4W CARBON RESIS	
	OTHERS		GV30080-001A	IC CLAMP	
		J 81	QNB0098-001	SPEAKER TERMINAL	
		J411	QNN0117-001	PIN JACK	
		J426	GP1FA550TZ	OUTPUT TRANSFORMER	
		L201	QQR0779-001Z	INDUCTOR	
		L401	QQR0779-001Z	INDUCTOR	
		L701	QQLZ005-R45	INDUCTOR	
		L702	QQLZ005-R45	INDUCTOR	
		CN315	QGF1205F1-10	CONNECTOR	
		CN612	QGB2510J1-04	CONNECTOR	
		CN701	QGB2510K2-07	CONNECTOR	
		CN702	QGB2510K2-10	CONNECTOR	
		CN711	QGB2510J1-07	CONNECTOR	
		CN712	QGB2510J1-10	CONNECT TERMINAL	
		CN870	QGB1214J1-20S	CONNECTOR	
		CN871	QGB1214J1-20S	CONNECTOR	
		FT111	QNG0020-001Z	FUSE CLIP	
		FT112	QNG0020-001Z	FUSE CLIP	
		FT511	QNG0020-001Z	FUSE CLIP	
		FT512	QNG0020-001Z	FUSE CLIP	
		FT521	QNG0020-001Z	FUSE CLIP	
		FT522	QNG0020-001Z	FUSE CLIP	
		FW431	QUM156-14Z4Z4	FLAT WIRE	
		FW703	QUM156-14BFZ4	FLAT WIRE	
		FW704	QUM154-15BFZ4	FLAT WIRE	
		FW705	QUM156-11Z4Z4	FLAT WIRE	
		RY 1	QSK0095-001	RELAY	
		TB101	QNZ0079-001Z	TAB	
		TB102	QNZ0079-001Z	TAB	

■ Electrical parts list (System control board)

Block No. 02

Block No	Item	Part Number	Description	Area
I.C.S	IC810	MN101C35DEA	I.C.(MICRO-COMPUTER)	
	IC811	BU4094BC	I.C.(M)	
DIODES	IC853	LB1641	I.C.(DIGI-OTHER)	
	IC915	GP1U281X	INFRARED DETECT UNIT	
	D360	MTZJ5.1B-T2	ZENER DIODE	
	D361	MTZJ11C-T2	ZENER DIODE	
	D362	MTZJ6.8C-T2	ZENER DIODE	
	D365	MTZJ9.1B-T2	ZENER DIODE	
	D366	MTZJ11C-T2	ZENER DIODE	
	D367	MTZJ10C-T2	ZENER DIODE	
	D368	MTZJ11C-T2	ZENER DIODE	
	D369	MTZJ10C-T2	ZENER DIODE	
	D370	MTZJ11C-T2	ZENER DIODE	
	D801	1N4003S-T5	SI.DIODE	
	D803	1SS119-02-T2	SI.DIODE	
	D804	1SS133-T2	SI.DIODE	
	D805	1SS133-T2	SI.DIODE	
	D831	MTZJ5.1B-T2	ZENER DIODE	
	D832	MTZJ5.1B-T2	ZENER DIODE	
	D853	MTZJ8.2C-T2	ZENER DIODE	
	D871	1SS133-T2	SI.DIODE	
	D872	1SS133-T2	SI.DIODE	
	D873	1SS133-T2	SI.DIODE	
	D955	SLR-342MC-T	LED	
	D956	SLR-342MC-T	LED	
	D957	SLR-342MC-T	LED	
	D958	SLR-342MC-T	LED	
	D961	1SS133-T2	SI.DIODE	
	D962	SLR-342VC-T	L.E.D.	
	D981	SLR-342MC-T	LED	
D982	SLR-342MC-T	LED		
D983	SLR-342MC-T	LED		
D984	SLR-342MC-T	LED		
TRANSISTORS	Q360	2SD2395/EF	SI.TRANSISTOR	
	Q361	KTC3199/GL-T	SI.TRANSISTOR	
	Q362	KTC3199/GL-T	SI.TRANSISTOR	
	Q366	2SD2395/EF	SI.TRANSISTOR	
	Q367	KTA1267/YG-T	SI.TRANSISTOR	
	Q368	KTC3199/GL-T	SI.TRANSISTOR	
	Q369	2SD2395/EF	SI.TRANSISTOR	
	Q370	KTC3199/GL-T	SI.TRANSISTOR	
	Q371	KTA1023/OY-T	SI.TRANSISTOR	
	Q372	KTA1023/OY-T	SI.TRANSISTOR	
	Q373	KRA104M-T	DIGITAL TRANSISTOR	
	Q374	KRC104M-T	DIGITAL TRANSISTOR	
	Q375	KTA1267/YG-T	SI.TRANSISTOR	
	Q801	KTC3195/OA-T	SI.TRANSISTOR	
	Q802	KTC3195/OA-T	SI.TRANSISTOR	
	Q803	KRC102M-T	DIGITAL TRANSISTOR	
	Q804	KRC102M-T	DIGITAL TRANSISTOR	
	Q805	KRC102M-T	DIGITAL TRANSISTOR	
	Q806	KRC102M-T	DIGITAL TRANSISTOR	
	Q807	KRC102M-T	DIGITAL TRANSISTOR	
	Q808	KRC102M-T	DIGITAL TRANSISTOR	
	Q809	KRC102M-T	DIGITAL TRANSISTOR	
	Q810	KRC102M-T	DIGITAL TRANSISTOR	
	Q811	KRC102M-T	DIGITAL TRANSISTOR	
	Q851	KTC3199/GL-T	SI.TRANSISTOR	
	Q870	2SA1175/HFE-T	TRANSISTOR	
	Q871	KTC3199/GL-T	SI.TRANSISTOR	
	Q872	KRC107M-T	DIGITAL TRANSISTOR	
	Q873	KTC3199/GL-T	SI.TRANSISTOR	
	Q874	KTC3199/GL-T	SI.TRANSISTOR	
	Q875	KRC102M-T	DIGITAL TRANSISTOR	
	Q877	KRC114M-T	SI.TRANSISTOR	
	Q878	KRA102M-T	DIGITAL TRANSISTOR	
	Q879	KRA102M-T	DIGITAL TRANSISTOR	
	Q961	KRA102M-T	DIGITAL TRANSISTOR	
	CAPACITORS	C360	QET1C06-476Z	47MF 16V E.CAPACITOR
C361		QDYB1CM-103Y	0.01MF 16V CER.CAPACITO	
C362		EETC1HM-226ZJ	22MF 50V E.CAPACITOR	
C366		EETC1HM-226ZJ	22MF 50V E.CAPACITOR	
C367		QDYB1CM-103Y	0.01MF 16V CER.CAPACITO	

Block No	Item	Part Number	Description	Area
	C370	QDYB1CM-103Y	0.01MF 16V CER.CAPACITO	
	C371	EETC1HM-226ZJ	22MF 50V E.CAPACITOR	
	C372	EETC1HM-226ZJ	22MF 50V E.CAPACITOR	
	C373	QDYB1CM-103Y	0.01MF 16V CER.CAPACITO	
	C374	EETC1HM-226ZJ	22MF 50V E.CAPACITOR	
	C801	QFLM1HJ-103Z	0.01MF 50V M CAPACITOR	
	C803	QETC0JM-477ZM	470MF 6.3V E.CAPACITOR	
	C804	QETN0JM-108Z	1000MF 6.3V AL E.CAPACIT	
	C805	QCGB1HK-102	1000PF 50V CER.CAPACITO	
	C806	QCGB1HK-102	1000PF 50V CER.CAPACITO	
	C807	QCSB1HJ-390Y	39PF 50V CER.CAPACITO	
	C808	QCSB1HJ-390Y	33PF 50V CER.CAPACITO	
	C809	QCSB1HJ-390Y	33PF 50V CER.CAPACITO	
	C810	QCSB1HJ-390Y	39PF 50V CER.CAPACITO	
	C811	QCGB1HK-102	1000PF 50V CER.CAPACITO	
	C812	QCSB1HJ-220	22PF 50V CER.CAPACITO	
	C813	QCSB1HJ-270Y	27PF 50V CER.CAPACITO	
	C814	QETN0JM-108Z	1000MF 6.3V CER.CAPACITO	
	C815	EETC1HM-226ZJ	22MF 50V E.CAPACITOR	
	C816	EETB1CM-476	47MF 16V E.CAPACITOR	
	C817	EETC1HM-226ZJ	22MF 50V E.CAPACITOR	
	C820	QCZ0205-155	1.5MF 25V C.CAPACITOR	
	C821	QDYB1CM-103Y	0.01MF 16V CER.CAPACITO	
	C831	QDYB1CM-103Y	0.01MF 16V CER.CAPACITO	
	C832	QDYB1CM-103Y	0.01MF 16V CER.CAPACITO	
	C834	EETC1HM-226ZJ	22MF 50V E.CAPACITOR	
	C835	QCGB1HK-102	1000PF 50V CER.CAPACITO	
	C855	QETB0JM-227	220MF 6.3V E.CAPACITOR	
	C856	EETB1AM-107E	100MF 10V E.CAPACITOR	
	C857	EETB1CM-476	47MF 16V E.CAPACITOR	
	C870	QDYB1CM-103Y	0.01MF 16V CER.CAPACITO	
	C871	EETB1HM-475E	4.7MF 50V E.CAPACITOR	
	C876	EETB1HM-105E	1MF 50V E.CAPACITOR	
	C877	QDGB1HK-681Y	680PF 50V C.CAPACITOR	
	C878	QDXB1CM-182Y	1800PF 16V C.CAPACITOR	
	C879	QCSB1HJ-390Y	33PF 50V CER.CAPACITO	
	C880	QFLM1HJ-153Z	0.015MF 50V M CAPACITOR	
	C883	QFVJ1HJ-104Z	0.1MF 50V TF CAPACITOR	
	C884	QETN1AM-227Z	220MF 10V E.CAPACITOR	
	C885	QFLM1HJ-103Z	0.01MF 50V M CAPACITOR	
	C886	QFLM1HJ-103Z	0.01MF 50V M CAPACITOR	
	C887	QFVJ1HJ-104Z	0.1MF 50V M CAPACITOR	
	C889	EETB1HM-105E	1MF 50V E.CAPACITOR	
	C890	QCGB1HK-102	1000PF 50V CER.CAPACITO	
	C950	QDYB1CM-103Y	0.01MF 16V CER.CAPACITO	
	C951	QDYB1CM-103Y	0.01MF 16V CER.CAPACITO	
	C991	QDYB1CM-103Y	0.01MF 16V CER.CAPACITO	
	C992	QDYB1CM-103Y	0.01MF 16V CER.CAPACITO	
	C1001	QDXB1CM-392Y	3900PF 50V CER.CAPACITO	
	C1002	QDXB1CM-392Y	3900PF 50V CER.CAPACITO	
	C1003	QDXB1CM-222Y	2200PF 50V CER.CAPACITO	
	C1004	QCGB1HK-102	1000PF 50V CER.CAPACITO	
	C1005	QCGB1HK-102	1000PF 50V CER.CAPACITO	
	C1006	QCGB1HK-102	1000PF 50V CER.CAPACITO	
RESISTORS	R360	QRZ9042-2R2X	2.2 FUSIBLE RESI	
	R361	QRZ9006-4R7X	4.7 F RESISTOR	
	R362	QRE141J-331Y	330 1/4W C RESISTOR	
	R363	QRE141J-331Y	330 1/4W C RESISTOR	
	R364	QRE141J-122Y	1.2K 1/4W C RESISTOR	
	R365	QRE141J-561Y	560 1/4W C RESISTOR	
	R366	QRE141J-561Y	560 1/4W C RESISTOR	
	R367	QRE141J-122Y	1.2K 1/4W C RESISTOR	
	R368	QRE141J-331Y	330 1/4W C RESISTOR	
	R372	QRE141J-4R7Y	4.7 1/4W C RESISTOR	
	R376	QRE141J-221Y	220 1/4W C RESISTOR	
	R377	QRE141J-561Y	560 1/4W C RESISTOR	
	R378	QRE141J-152Y	1.5K 1/4W CARBON RESIS	
	R381	QRE141J-182Y	1.8K 1/4W C RESISTOR	
	R382	QRE141J-221Y	220 1/4W C RESISTOR	
	R384	QRE141J-272Y	2.7K 1/4W C RESISTOR	
	R385	QRE141J-562Y	5.6K 1/4W C RESISTOR	
	R388	QRE141J-881Y	680 1/4W CARBON RESIS	
	R389	QRE141J-103Y	10K 1/4W CARBON RESIS	

MX-J550R
MX-J552R

■ Electrical parts list (System control board)

Block No. 02

Block No.	Item	Part Number	Description	Area	Block No.	Item	Part Number	Description	Area
RESISTORS	R395	QRZ9042-2R2X	2.2 FUSIBLE RESI		R921	QRE141J-102Y	1K 1/4W C RESISTOR		
	R396	QRZ9042-2R2X	2.2 FUSIBLE RESI		R922	QRE141J-102Y	1K 1/4W C RESISTOR		
	R801	QRE141J-331Y	330 1/4W C RESISTOR		R923	QRE141J-122Y	1.2K 1/4W C RESISTOR		
	R802	QRE141J-223Y	22K 1/4W C RESISTOR		R924	QRE141J-152Y	1.5K 1/4W CARBON RESIS		
	R803	QRE141J-223Y	22K 1/4W C RESISTOR		R925	QRE141J-222Y	2.2K 1/4W C RESISTOR		
	R804	QRE141J-822Y	8.2K 1/4W C RESISTOR		R926	QRE141J-272Y	2.7K 1/4W C RESISTOR		
	R805	QRE141J-822Y	8.2K 1/4W C RESISTOR		R927	QRE141J-392Y	3.9K 1/4W C RESISTOR		
	R806	QRE141J-124Y	120K 1/4W C RESISTOR		R928	QRE141J-562Y	5.6K 1/4W C RESISTOR		
	R807	QRE141J-103Y	10K 1/4W CARBON RESIS		R931	QRE141J-202Y	2K 1/4W C RESISTOR		
	R808	QRE141J-103Y	10K 1/4W CARBON RESIS		R932	QRE141J-122Y	1.2K 1/4W C RESISTOR		
	R809	QRE141J-103Y	10K 1/4W CARBON RESIS		R933	QRE141J-152Y	1.5K 1/4W CARBON RESIS		
	R810	QRE141J-103Y	10K 1/4W CARBON RESIS		R934	QRE141J-222Y	2.2K 1/4W C RESISTOR		
	R811	QRE141J-103Y	10K 1/4W CARBON RESIS		R935	QRE141J-272Y	2.7K 1/4W C RESISTOR		
	R812	QRE141J-103Y	10K 1/4W CARBON RESIS		R936	QRE141J-392Y	3.9K 1/4W C RESISTOR		
	R813	QRE141J-103Y	10K 1/4W CARBON RESIS		R937	QRE141J-562Y	5.6K 1/4W C RESISTOR		
	R814	QRE141J-562Y	5.6K 1/4W C RESISTOR		R938	QRE141J-103Y	10K 1/4W CARBON RESIS		
	R815	QRE141J-104Y	100K 1/4W C RESISTOR		R939	QRE141J-103Y	10K 1/4W CARBON RESIS		
	R816	QRE141J-104Y	100K 1/4W C RESISTOR		R941	QRE141J-102Y	1K 1/4W C RESISTOR		
	R817	QRE141J-103Y	10K 1/4W CARBON RESIS		R942	QRE141J-102Y	1K 1/4W C RESISTOR		
	R818	QRE141J-103Y	10K 1/4W CARBON RESIS		R943	QRE141J-122Y	1.2K 1/4W C RESISTOR		
	R819	QRE141J-102Y	1K 1/4W C RESISTOR		R944	QRE141J-152Y	1.5K 1/4W CARBON RESIS		
	R820	QRE141J-102Y	1K 1/4W C RESISTOR		R945	QRE141J-222Y	2.2K 1/4W C RESISTOR		
	R821	QRE141J-103Y	10K 1/4W C RESISTOR		R946	QRE141J-272Y	2.7K 1/4W C RESISTOR		
	R822	QRE141J-103Y	10K 1/4W C RESISTOR		R951	QRE141J-334Y	330K 1/4W C RESISTOR		
	R823	QRE141J-102Y	1K 1/4W C RESISTOR		R952	QRE141J-392Y	3.9K 1/4W C RESISTOR		
	R824	QRE141J-102Y	1K 1/4W C RESISTOR		R953	QRE141J-562Y	5.6K 1/4W C RESISTOR		
	R827	QRE141J-103Y	10K 1/4W CARBON RESIS		R954	QRE141J-103Y	10K 1/4W CARBON RESIS		
	R831	QRE141J-104Y	100K 1/4W C RESISTOR		R955	QRE141J-680Y	68 1/4W C RESISTOR		
	R834	QRE141J-104Y	100K 1/4W C RESISTOR		R956	QRE141J-680Y	68 1/4W C RESISTOR		
	R835	QRE141J-104Y	100K 1/4W C RESISTOR		R961	QRE141J-201Y	200 1/4W CARBON RESIS		
	R836	QRE141J-104Y	100K 1/4W C RESISTOR		R962	QRE141J-103Y	10K 1/4W CARBON RESIS		
	R837	QRE141J-104Y	100K 1/4W C RESISTOR		R963	QRE141J-103Y	10K 1/4W CARBON RESIS		
	R838	QRE141J-102Y	1K 1/4W C RESISTOR		R964	QRE141J-334Y	330K 1/4W C RESISTOR		
	R839	QRE141J-102Y	1K 1/4W C RESISTOR		R981	QRE141J-680Y	68 1/4W C RESISTOR		
	R840	QRE141J-103Y	10K 1/4W CARBON RESIS		R982	QRE141J-680Y	68 1/4W C RESISTOR		
	R841	QRE141J-103Y	10K 1/4W CARBON RESIS		R985	QRE141J-392Y	3.9K 1/4W C RESISTOR		
	R842	QRE141J-103Y	10K 1/4W CARBON RESIS		R986	QRE141J-562Y	5.6K 1/4W C RESISTOR		
	R843	QRE141J-221Y	220 1/4W C RESISTOR		R991	QRE141J-102Y	1K 1/4W C RESISTOR		
	R844	QRE141J-103Y	10K 1/4W CARBON RESIS		R992	QRE141J-102Y	1K 1/4W C RESISTOR		
	R845	QRE141J-102Y	1K 1/4W C RESISTOR		R993	QRE141J-122Y	1.2K 1/4W C RESISTOR		
	R846	QRE141J-102Y	1K 1/4W C RESISTOR		R994	QRE141J-152Y	1.5K 1/4W CARBON RESIS		
	R847	QRE141J-102Y	1K 1/4W C RESISTOR		R995	QRE141J-222Y	2.2K 1/4W C RESISTOR		
	R848	QRE141J-331Y	330 1/4W C RESISTOR		R996	QRE141J-272Y	2.7K 1/4W C RESISTOR		
	R849	QRE141J-102Y	1K 1/4W C RESISTOR		RA801	QRB169J-104	100K 1/10W RESISTOR ARR		
	R850	QRE141J-681Y	680 1/4W C RESISTOR		RA802	QRB169J-104	100K 1/10W RESISTOR ARR		
	R851	QRE141J-391Y	390 1/4W C RESISTOR		OTHERS	E3400-439	FELT SPACER		
	R852	QRE141J-4R7Y	4.7 1/4W C RESISTOR			GV30032-001A	FL HOLDER		
	R856	QRE141J-100Y	10 1/4W C RESISTOR		L801	QQL29BJ-100Z	INDUCTOR		
	R860	QRE141J-684Y	680K 1/4W C RESISTOR		L802	QQL231K-220Y	INDUCTOR		
	R870	QRE141J-473Y	47K 1/4W C RESISTOR		L803	QQL29BJ-100Z	INDUCTOR		
	R871	QRE141J-102Y	1K 1/4W C RESISTOR		L804	QQR0779-001Z	INDUCTOR		
	R872	QRE141J-103Y	10K 1/4W CARBON RESIS		L805	QQL29BJ-100Z	INDUCTOR		
	R873	QRE141J-103Y	10K 1/4W CARBON RESIS		L806	QQL29BJ-100Z	INDUCTOR		
	R874	QRE141J-182Y	1.8K 1/4W C RESISTOR		L807	QQR0779-001Z	INDUCTOR		
	R875	QRE141J-472Y	4.7K 1/4W CARBON RESIS		L808	QQR0779-001Z	INDUCTOR		
	R876	QRE141J-103Y	10K 1/4W CARBON RESIS		L851	QQL29BJ-100Z	INDUCTOR		
	R879	QRE141J-473Y	47K 1/4W C RESISTOR		L870	QQR0779-001Z	INDUCTOR		
	R880	QRE141J-225Y	2.2M 1/4W C RESISTOR		S921	QSW0825-001Z	TACT SWITCH		
	R882	QRE141J-104Y	100K 1/4W C RESISTOR		S922	QSW0825-001Z	TACT SWITCH		
	R883	QRE141J-220Y	22 1/4W CARBON RESIS		S923	QSW0825-001Z	TACT SWITCH		
	R885	QRE141J-102Y	1K 1/4W C RESISTOR		S924	QSW0825-001Z	TACT SWITCH		
	R886	QRE141J-102Y	1K 1/4W C RESISTOR		S925	QSW0825-001Z	TACT SWITCH		
	R887	QRE141J-102Y	1K 1/4W C RESISTOR		S926	QSW0825-001Z	TACT SWITCH		
	R888	QRE141J-102Y	1K 1/4W C RESISTOR		S927	QSW0825-001Z	TACT SWITCH		
	R889	QRE141J-102Y	1K 1/4W C RESISTOR		S928	QSW0825-001Z	TACT SWITCH		
	R891	QRE141J-104Y	100K 1/4W C RESISTOR		S931	QSW0825-001Z	TACT SWITCH		
	R892	QRE141J-104Y	100K 1/4W C RESISTOR		S932	QSW0825-001Z	TACT SWITCH		
	R893	QRE141J-753Y	75K 1/4W C RESISTOR		S933	QSW0825-001Z	TACT SWITCH		
	R894	QRE141J-334Y	330K 1/4W C RESISTOR		S934	QSW0825-001Z	TACT SWITCH		
	R895	QRE141J-152Y	1.5K 1/4W CARBON RESIS		S935	QSW0825-001Z	TACT SWITCH		
	R896	QRE141J-103Y	10K 1/4W C RESISTOR		S936	QSW0825-001Z	TACT SWITCH		
	R897	QRE141J-152Y	1.5K 1/4W CARBON RESIS		S937	QSW0825-001Z	TACT SWITCH		
	R898	QRE141J-103Y	10K 1/4W C RESISTOR		S938	QSW0825-001Z	TACT SWITCH		

■ Electrical parts list (System control board)

Block No. 02

Block No	Item	Part Number	Description	Area
OTHERS	S939	QSW0825-001Z	TACT SWITCH	
	S941	QSW0825-001Z	TACT SWITCH	
	S942	QSW0825-001Z	TACT SWITCH	
	S943	QSW0825-001Z	TACT SWITCH	
	S944	QSW0825-001Z	TACT SWITCH	
	S945	QSW0825-001Z	TACT SWITCH	
	S946	QSW0825-001Z	TACT SWITCH	
	S948	QSW0518-001	PUSH SWITCH	
	S949	QSW0122-001	PUSH SWITCH	
	S952	QSW0825-001Z	TACT SWITCH	
	S953	QSW0825-001Z	TACT SWITCH	
	S963	QSW0825-001Z	TACT SWITCH	
	S985	QSW0825-001Z	TACT SWITCH	
	S986	QSW0825-001Z	TACT SWITCH	
	S991	QSW0825-001Z	TACT SWITCH	
	S992	QSW0825-001Z	TACT SWITCH	
	S993	QSW0825-001Z	TACT SWITCH	
	S994	QSW0825-001Z	TACT SWITCH	
	S995	QSW0825-001Z	TACT SWITCH	
	S996	QSW0825-001Z	TACT SWITCH	
	S997	QSW0825-001Z	TACT SWITCH	
	X801	QAX0416-001Z	CERA LOCK	
	X802	QAX0401-001	CRYSTAL	
	CN602	QGB2510K2-04	CONNECTOR	
	CN713	QGD2503F1-06	4P PLUG ASSY	
	CN815	QGD2504C1-03Z	CONNECT TERMINAL	
	CN850	QGD2504C1-03Z	CONNECT TERMINAL	
	CN851	QGD2504C1-04Z	CONNECT TERMINAL	
	CN860	QGB1214K1-20S	CONNECT TERMINAL	
	CN861	QGB1214K1-20S	CONNECT TERMINAL	
	CN862	QGD2504C1-03Z	CONNECT TERMINAL	
	CN863	QGD2504C1-03Z	CONNECT TERMINAL	
	CN865	QGF1205C1-13	CONNECT TERMINAL	
	CN867	QGA2501C1-02	CONNECTOR	
	CN868	QGF1016C1-19	CONNECTOR	
	CN869	QGF1205C1-11	CONNECTOR	
	CN879	QGF1031C1-09S	CONNECT TERMINAL	
	CN880	QGF1205C1-11	CONNECTOR	
	CN883	QGD2504C1-03Z	CONNECT TERMINAL	
	CN884	QGD2504C1-03Z	CONNECT TERMINAL	
	CN900	QGD2504C1-04Z	CONNECT TERMINAL	
	CN901	QGD2504C1-04Z	CONNECT TERMINAL	
	CN979	QGF1016F1-09	CONNECT TERMINAL	
	CN990	QGF1205F1-11	CONNECTOR	
	EP201	E409182-001SM	EARTH TERMINAL	
	FL801	QLF0074-001	FLUORESCENT DISPLAY TUBE	
	FW852	QUM153-06Z4Z4	FLAT WIRE	
	FW862	QUM026-26DGZ3	FLAT WIRE	
	FW883	QUM026-26DGZ3	FLAT WIRE	
	FW915	QUM153-12BFZ4	FLAT WIRE	
	FW950	QUM157-11BFZ4	FLAT WIRE	
	FW951	QUM154-06Z4Z4	FLAT WIRE	
FW952	QUM024-16DGZ3	WIRE		
JS950	QSW0857-001	VARIABLE RESISTOR		
JS992	QSW0857-001	VARIABLE RESISTOR		
J1001	QNS0159-001	MINI JACK		
L1001	QQL231K-470Y	INDUCTOR		
L1002	QQL231K-470Y	INDUCTOR		
L1003	QQR0779-001Z	INDUCTOR		
SP801	VYH7653-001	I.C.PROTECTOR		

MX-J550R
MX-J552R

■ Electrical parts list (Tuner board)

Block No. 03

Block No	Item	Part Number	Description	Area
I.C.S	IC 1	LA1838	I.C(M)	
	IC 2	LC72138N	I.C(M)	
	IC 3	LC72723	I.C(DIGI-MOS)	
DIODES	D 1	1SS133-T2	SI.DIODE	
	D 2	1SS133-T2	SI.DIODE	
	D 3	1SS133-T2	SI.DIODE	
	D 4	1SS133-T2	SI.DIODE	
	D 11	1SS133-T2	SI.DIODE	
TRANSISTORS	Q 1	2SC2814/4-S/-X	TRANSISTOR	
	Q 2	2SC2412K/R/-X	SI.TRANSISTOR	
	Q 3	2SC2412K/R/-X	SI.TRANSISTOR	
	Q 4	DTA114YKA-X	DIGITAL TRANSISTOR	
CAPACITORS	Q 5	DTA114YKA-X	DIGITAL TRANSISTOR	
	C 1	NCB21HK-223X	0.022MF 50V CER.CAPACITO	
	C 2	NCB21HK-103X	0.01MF 50V CER.CAPACITO	
	C 3	EETC1CM-106ZJ	10MF 16V AL.E.CAPACIT	
	C 4	NCB21HK-103X	0.01MF 50V CER.CAPACITO	
	C 6	NCB21HK-102X	1000PF 50V C CAPACITOR	
	C 7	NCB21HK-102X	1000PF 50V C CAPACITOR	
	C 8	NCB21HK-102X	1000PF 50V C CAPACITOR	
	C 9	NCB21HK-102X	1000PF 50V C CAPACITOR	
	C 10	NDC21HJ-120X	12PF 50V CAPACITOR	
	C 11	NCB21HK-104X	0.1MF 50V C CAPACITOR	
	C 12	NCB21HK-473X	0.047MF 50V C CAPACITOR	
	C 13	NDC21HJ-120X	12PF 50V CAPACITOR	
	C 14	EETB1AM-107E	100MF 10V E.CAPACITOR	
	C 15	NDC21HJ-120X	12PF 50V CAPACITOR	
	C 16	NDC21HJ-120X	12PF 50V CAPACITOR	
	C 17	NCB21HK-392X	3900PF 50V C CAPACITOR	
	C 18	QENB1HM-474	0.47MF 50V NP E.CAPACIT	
	C 19	NCB21HK-473X	0.047MF 50V C CAPACITOR	
	C 20	NCB21HK-102X	1000PF 50V C CAPACITOR	
	C 21	NCB21HK-223X	0.022MF 50V CER.CAPACITO	
	C 22	NCS21HJ-151X	150PF 50V CER.CAPACITO	
	C 23	NCS21HJ-151X	150PF 50V CER.CAPACITO	
	C 24	NCS21HJ-151X	150PF 50V CER.CAPACITO	
	C 25	EETB1AM-107E	100MF 10V E.CAPACITOR	
	C 26	NCB21HK-103X	0.01MF 50V CER.CAPACITO	
	C 27	NCB21HK-103X	0.01MF 50V CER.CAPACITO	
	C 30	EETB1AM-107E	100MF 10V E.CAPACITOR	
	C 31	QEK1CM-226Z	22MF 16V E CAPACITOR	
	C 32	NCB21HK-473X	0.047MF 50V C CAPACITOR	
	C 33	NCB21HK-473X	0.047MF 50V C CAPACITOR	
	C 34	NCB21HK-223X	0.022MF 50V CER.CAPACITO	
	C 35	NCB21HK-473X	0.047MF 50V C CAPACITOR	
	C 36	EETB1HM-105E	1MF 50V E.CAPACITOR	
	C 37	EETB1HM-105E	1MF 50V E.CAPACITOR	
	C 38	QETC1HM-224Z	0.22MF 50V AL.E.CAPACIT	
	C 39	EETB1HM-105E	1MF 50V E.CAPACITOR	
	C 40	QETN1CM-106Z	10MF 16V E.CAPACITOR	
	C 41	QETN1CM-106Z	10MF 16V E.CAPACITOR	
	C 42	NCB21HK-182X	1800PF 50V C CAPACITOR	
	C 43	NCB21HK-182X	1800PF 50V C CAPACITOR	
	C 44	QETN1CM-106Z	10MF 16V E.CAPACITOR	
	C 45	QETN1CM-106Z	10MF 16V E.CAPACITOR	
	C 46	NCB21HK-223X	0.022MF 50V CER.CAPACITO	
	C 47	EETB1HM-105E	1MF 50V E.CAPACITOR	
C 48	NCB21HK-222X	2200PF 50V C CAPACITOR		
C 49	NCS21HJ-471X	470PF 50V C CAPACITOR		
C 50	QEK1CM-226Z	22MF 16V E CAPACITOR		
C 51	QEK1HM-105Z	1MF 50V E.CAPA I.M		
C 52	QFVJ1HJ-274Z	0.27MF 50V CAPACITOR		
C 53	EETB1CM-226E	22MF 16V E.CAPACITOR		
C 54	NCB21HK-473X	0.047MF 50V C CAPACITOR		
C 55	NCS21HJ-330X	33PF 50V C CAPACITOR		
C 56	NCS21HJ-100X	10PF 50V C CAPACITOR		
C 57	NCB21HK-102X	1000PF 50V C CAPACITOR		
C 58	NCB21HK-473X	0.047MF 50V C CAPACITOR		
C 59	NCB21HK-102X	1000PF 50V C CAPACITOR		
C 70	NCS21HJ-220X	22PF 50V C CAPACITOR		
C 71	NCS21HJ-220X	22PF 50V C CAPACITOR		
C 72	NCB21HK-561X	560PF 50V C CAPACITOR		
C 73	NCB21HK-104X	0.1MF 50V C CAPACITOR		

Block No	Item	Part Number	Description	Area
RESISTORS	C 74	NCB21HK-104X	0.1MF 50V C CAPACITOR	
	C 75	QETC1HM-106ZM	10MF 50V E.CAPACITOR	
	C 76	NCB21HK-331X	330PF 50V CER.CAPACITO	
	R 2	NRSA02J-331X	MG RESISTOR	
	R 3	NRSA02J-224X	METAL GLAZE	
	R 4	NRSA02J-331X	MG RESISTOR	
	R 5	NRSA02J-560X	METAL GLAZE	
	R 6	NRSA02J-240X	METAL GLAZE	
	R 10	NRSA02J-222X	MG RESISTOR	
	R 11	NRSA02J-472X	MG RESISTOR	
	R 12	NRSA02J-472X	MG RESISTOR	
	R 13	NRSA02J-103X	METAL GLAZE	
	R 14	NRSA02J-104X	METAL GLAZE	
	R 15	NRSA02J-332X	MG RESISTOR	
	R 16	NRSA02J-472X	MG RESISTOR	
	R 17	QRZ9005-680X	68 FUSIBLE RESI	
	R 18	NRSA02J-102X	MG RESISTOR	
	R 19	NRSA02J-102X	MG RESISTOR	
	R 20	NRSA02J-102X	MG RESISTOR	
	R 21	NRSA02J-562X	MG RESISTOR	
	R 22	NRSA02J-472X	MG RESISTOR	
	R 23	NRSA02J-182X	MG RESISTOR	
	R 24	NRSA02J-103X	METAL GLAZE	
	R 25	NRSA02J-331X	MG RESISTOR	
	R 26	NRSA02J-222X	MG RESISTOR	
	R 27	NRSA02J-103X	METAL GLAZE	
	R 28	NRSA02J-103X	METAL GLAZE	
	R 29	NRSA02J-103X	METAL GLAZE	
	R 30	NRSA02J-122X	MG RESISTOR	
	R 31	NRSA02J-102X	MG RESISTOR	
	R 32	NRSA02J-102X	MG RESISTOR	
	R 33	NRSA02J-331X	MG RESISTOR	
	R 34	NRSA02J-470X	MG RESISTOR	
	R 35	NRSA02J-562X	MG RESISTOR	
	R 36	NRSA02J-332X	MG RESISTOR	
R 37	NRSA02J-103X	METAL GLAZE		
R 38	NRSA02J-393X	MG RESISTOR		
R 39	NRSA02J-393X	MG RESISTOR		
R 40	NRSA02J-393X	MG RESISTOR		
R 41	NRSA02J-332X	MG RESISTOR		
R 60	NRSA02J-0R0X	MG RESISTOR		
R 70	NRSA02J-103X	METAL GLAZE		
R 71	NRSA02J-102X	MG RESISTOR		
R 72	NRSA02J-102X	MG RESISTOR		
R 73	NRSA02J-102X	MG RESISTOR		
OTHERS	J 1	QNB0014-001	ANTENNA TERMINAL	
	L 1	QGR1094-001	COIL BLOCK	
	L 2	QQL231K-330Y	INDUCTOR	
	L 3	QQL231K-4R7Y	PEAKING COIL	
	L 70	QQL231K-101Y	INDUCTOR	
	T 1	QQR0783-001	LF.TRANSFORMER	
	X 1	QAX0402-001	CRYSTAL	
	X 70	QAX0263-001Z	CRYSTAL	
	CF 1	QAX0420-001	C FILTER	
	CF 2	QAX0458-001Z	HIDEO	
CF 3	QAX0610-001Z	CERAMIC FILTER		
CN 1	QGF1205F1-13	CONNECTOR		
TU 1	QAU0160-001	FM FRONT END		

■ Electrical parts list (CD servo board) Block No. 04

▲	Item	Parts number	Parts name	Remarks	Area	▲	Item	Parts number	Parts name	Remarks	Area
	C 251	NCS21HJ-100X	C CAPACITOR				CN651	QGF1016F1-19	CONNECTOR	MAIN	
	C 252	NCS21HJ-100X	C CAPACITOR				CN652	QGF1016F1-05	CONNECTOR	OSD	
	C 253	NCB21EK-104X	C CAPACITOR				CN653	QGF1016F1-13	CONNECTOR	CD TEXT	
	C 254	QERF1AM-476Z	E CAPACITOR	47MF 20% 10V			CN801	QGA2001C1-06	6P PLUG ASSY	TRAVERSE	
	C 255	NCB21EK-104X	C CAPACITOR				CN851	QGD2503F1-03	SOCKET	DISC DETECTION	
	C 281	NCB21HK-223X	C CAPACITOR				CN854	QGB2016K1-07	CONNECTOR	TRAY SWITCH	
	C 291	QERF1AM-476Z	E CAPACITOR	47MF 20% 10V			CN855	QGB2012K2-10	CONNECTOR	CAM SWITCH	
	C 601	NCB21HK-102X	C CAPACITOR				IC251	UPD78055GCA37	IC	MICOM	
	C 602	NCB21HK-102X	C CAPACITOR				IC601	AN8806SB-W	IC	RF AMP	
	C 603	NCB21HK-223X	C CAPACITOR				IC651	MN35510	IC	DSP & DAC	
	C 604	NCB21HK-223X	C CAPACITOR				IC801	BA6897FP-W	IC	PU DRIVE	
	C 605	NCS21HJ-271X	C CAPACITOR				IC851	TA8409S	IC	L MOTOR DRIVE	
	C 606	NCS21HJ-181X	C CAPACITOR				IC852	TA8409S	IC	R MOTOR DRIVE	
	C 607	NCB21HK-222X	C CAPACITOR				L 851	QQL01BK-100Z	INDUCTOR	VS DE-COUPLE	
	C 608	NCB21HK-223X	C CAPACITOR				L 853	QQL01BK-100Z	INDUCTOR	L MOTOR	
	C 610	NCB21EK-104X	C CAPACITOR				L 854	QQL01BK-100Z	INDUCTOR	R MOTOR	
	C 611	NCB21EK-104X	C CAPACITOR				Q 291	2SB1357/EF-T	TRANSISTOR		
	C 612	QER41HM-105	E CAPACITOR	1.0MF 20% 50V			Q 631	2SA1037AK/RS-X	TRANSISTOR		
	C 613	NCS21HJ-101X	C CAPACITOR				Q 842	DTA144ES-T	TRANSISTOR		
	C 614	NCB21HK-273X	C CAPACITOR				R 251	NRSA02J-102X	MG RESISTOR		
	C 615	NCB21HK-472X	C CAPACITOR				R 252	NRSA02J-102X	MG RESISTOR		
	C 616	NCB21HK-103X	C CAPACITOR				R 253	NRSA02J-102X	MG RESISTOR		
	C 617	NCS21HJ-331X	C CAPACITOR				R 254	NRSA02J-102X	MG RESISTOR		
	C 621	NCB21EK-104X	C CAPACITOR				R 255	NRSA02J-102X	MG RESISTOR		
	C 623	NCF21CZ-105X	C CAPACITOR				R 256	NRSA02J-102X	MG RESISTOR		
	C 624	QER41AM-107	E CAPACITOR	100MF 20% 10V			R 257	NRSA02J-102X	MG RESISTOR		
	C 631	QER41CM-106	E CAPACITOR	10MF 20% 16V			R 258	NRSA02J-102X	MG RESISTOR		
	C 632	NCF21CZ-105X	C CAPACITOR				R 259	NRSA02J-101X	MG RESISTOR		
	C 633	NCB21HK-223X	C CAPACITOR				R 260	NRSA02J-102X	MG RESISTOR		
	C 651	NCS21HJ-120X	C CAPACITOR				R 261	NRSA02J-102X	MG RESISTOR		
	C 652	NCS21HJ-150X	C CAPACITOR				R 262	NRSA02J-102X	MG RESISTOR		
	C 653	NCB21EK-104X	C CAPACITOR				R 263	NRSA02J-102X	MG RESISTOR		
	C 654	NCB21HK-223X	C CAPACITOR				R 264	NRSA02J-102X	MG RESISTOR		
	C 655	QER41AM-227	E CAPACITOR	220MF 20% 10V			R 265	NRSA02J-223X	MG RESISTOR		
	C 656	NCB21EK-104X	C CAPACITOR				R 266	NRSA02J-102X	MG RESISTOR		
	C 657	NCB21HK-222X	C CAPACITOR				R 267	NRSA02J-102X	MG RESISTOR		
	C 658	NCB21HK-222X	C CAPACITOR				R 268	NRSA02J-102X	MG RESISTOR		
	C 661	NCB21EK-104X	C CAPACITOR				R 269	NRSA02J-102X	MG RESISTOR		
	C 662	QER41AM-107	E CAPACITOR	100MF 20% 10V			R 274	NRSA02J-102X	MG RESISTOR		
	C 663	NCB21EK-104X	C CAPACITOR				R 275	NRSA02J-102X	MG RESISTOR		
	C 664	NCB21HK-223X	C CAPACITOR				R 276	NRSA02J-102X	MG RESISTOR		
	C 665	NCB21HK-223X	C CAPACITOR				R 277	NRSA02J-102X	MG RESISTOR		
	C 666	NCS21HJ-471X	C CAPACITOR				R 278	NRSA02J-102X	MG RESISTOR		
	C 667	NCF21CZ-105X	C CAPACITOR				R 279	NRSA02J-102X	MG RESISTOR		
	C 668	NCB21HK-473X	C CAPACITOR				R 281	NRSA02J-102X	MG RESISTOR		
	C 671	NCB21EK-104X	C CAPACITOR				R 282	NRSA02J-102X	MG RESISTOR		
	C 672	QER41AM-107	E CAPACITOR	100MF 20% 10V			R 283	NRSA02J-102X	MG RESISTOR		
	C 801	NCB21HK-822X	C CAPACITOR				R 284	NRSA02J-102X	MG RESISTOR		
	C 802	NCB21HK-152X	C CAPACITOR				R 285	NRSA02J-102X	MG RESISTOR		
	C 811	NCS21HJ-221X	C CAPACITOR				R 286	NRSA02J-102X	MG RESISTOR		
	C 812	NCS21HJ-221X	C CAPACITOR				R 287	NRSA02J-102X	MG RESISTOR		
	C 813	NCS21HJ-221X	C CAPACITOR				R 288	NRSA02J-102X	MG RESISTOR		
	C 814	NCS21HJ-221X	C CAPACITOR				R 291	NRSA02J-122X	MG RESISTOR		
	C 821	NCF21CZ-105X	C CAPACITOR				R 292	NRSA02J-103X	MG RESISTOR		
	C 822	QER41AM-227	E CAPACITOR	220MF 20% 10V			R 293	NRSA02J-102X	MG RESISTOR		
	C 851	QER41CM-106	E CAPACITOR	10MF 20% 16V			R 601	NRSA02J-274X	MG RESISTOR		
	C 852	QER41CM-106	E CAPACITOR	10MF 20% 16V			R 602	NRSA02J-154X	MG RESISTOR		
	C 855	NCB21EK-104X	C CAPACITOR				R 603	NRSA02J-273X	MG RESISTOR		
	C 859	NCF21CZ-105X	C CAPACITOR				R 604	NRSA02J-104X	MG RESISTOR		
	C 860	NCF21CZ-105X	C CAPACITOR				R 605	NRSA02J-154X	MG RESISTOR		
	CN151	QGF1016F1-15	15FFC CONNECTOR	VIDEO CD			R 606	NRSA02J-474X	MG RESISTOR		
	CN152	QGA2001F1-12	12P CN RIG	VIDEO CD			R 607	NRSA02J-102X	MG RESISTOR		
	CN601	QGF1016F1-15	15FFC CONNECTOR	TRAVERSE			R 611	NRSA02J-113X	MG RESISTOR		

MX-J550R
MX-J552R

■ Electrical parts list (CD servo board) Block No. 04

△	Item	Parts number	Parts name	Remarks	Area
	R 612	NRSA02J-125X	MG RESISTOR		
	R 631	NRSA02J-2R2X	MG RESISTOR		
	R 632	NRSA02J-100X	MG RESISTOR		
	R 634	NRSA02J-120X	MG RESISTOR		
	R 635	NRSA02J-121X	MG RESISTOR		
	R 636	NRSA02J-910X	MG RESISTOR		
	R 651	NRSA02J-271X	MG RESISTOR		
	R 652	NRSA02J-220X	MG RESISTOR		
	R 657	NRSA02J-102X	MG RESISTOR		
	R 658	NRSA02J-102X	MG RESISTOR		
	R 661	NRSA02J-220X	MG RESISTOR		
	R 662	NRSA02J-471X	MG RESISTOR		
	R 663	NRSA02J-124X	MG RESISTOR		
	R 665	NRSA02J-683X	MG RESISTOR		
	R 666	NRSA02J-155X	MG RESISTOR		
	R 667	NRSA02J-562X	MG RESISTOR		
	R 671	NRSA02J-102X	MG RESISTOR		
	R 672	NRSA02J-102X	MG RESISTOR		
	R 673	NRSA02J-102X	MG RESISTOR		
	R 674	NRSA02J-101X	MG RESISTOR		
	R 675	NRSA02J-102X	MG RESISTOR		
	R 676	NRSA02J-102X	MG RESISTOR		
	R 677	NRSA02J-102X	MG RESISTOR		
	R 678	NRSA02J-102X	MG RESISTOR		
	R 679	NRSA02J-102X	MG RESISTOR		
	R 680	NRSA02J-102X	MG RESISTOR		
	R 681	NRSA02J-102X	MG RESISTOR		
	R 682	NRSA02J-102X	MG RESISTOR		
	R 683	NRSA02J-102X	MG RESISTOR		
	R 684	NRSA02J-271X	MG RESISTOR		
	R 685	NRSA02J-102X	MG RESISTOR		
	R 686	NRSA02J-101X	MG RESISTOR		
	R 687	NRSA02J-102X	MG RESISTOR		
	R 688	NRSA02J-101X	MG RESISTOR		
	R 689	NRSA02J-102X	MG RESISTOR		
	R 690	NRSA02J-101X	MG RESISTOR		
	R 691	NRSA02J-101X	MG RESISTOR		
	R 692	NRSA02J-101X	MG RESISTOR		
	R 693	NRSA02J-471X	MG RESISTOR		
	R 694	NRSA02J-102X	MG RESISTOR		
	R 801	NRSA02J-222X	MG RESISTOR		
	R 802	NRSA02J-472X	MG RESISTOR		
	R 803	NRSA02J-123X	MG RESISTOR		
	R 804	NRSA02J-154X	MG RESISTOR		
	R 805	NRSA02J-123X	MG RESISTOR		
	R 806	NRSA02J-223X	MG RESISTOR		
	R 807	NRSA02J-222X	MG RESISTOR		
	R 808	NRSA02J-223X	MG RESISTOR		
	R 811	NRSA02J-473X	MG RESISTOR		
	R 812	NRSA02J-223X	MG RESISTOR		
	R 831	NRSA02J-151X	MG RESISTOR		
	R 832	NRSA02J-103X	MG RESISTOR		
	R 842	NRSA02J-472X	MG RESISTOR		
	R 851	NRSA02J-102X	MG RESISTOR		
	R 852	NRSA02J-102X	MG RESISTOR		
	R 853	NRSA02J-102X	MG RESISTOR		
	R 854	NRSA02J-102X	MG RESISTOR		
	R 855	NRSA02J-102X	MG RESISTOR		
	R 856	NRSA02J-102X	MG RESISTOR		
	R 857	NRSA02J-272X	MG RESISTOR		
	R 859	NRSA02J-181X	MG RESISTOR		
	R 861	NRSA02J-102X	MG RESISTOR		
	R 862	NRSA02J-102X	MG RESISTOR		

△	Item	Parts number	Parts name	Remarks	Area
	R 863	NRSA02J-102X	MG RESISTOR		
	R 864	NRSA02J-102X	MG RESISTOR		
	R 865	NRSA02J-102X	MG RESISTOR		
	R 866	NRSA02J-102X	MG RESISTOR		
	R 880	NRSA02J-102X	MG RESISTOR		
	R 881	NRSA02J-102X	MG RESISTOR		
	R 882	NRSA02J-102X	MG RESISTOR		
	R 883	NRSA02J-102X	MG RESISTOR		
	R 884	NRSA02J-102X	MG RESISTOR		
	R 885	NRSA02J-102X	MG RESISTOR		
	R 886	NRSA02J-102X	MG RESISTOR		
	R 887	NRSA02J-102X	MG RESISTOR		
	W 601	QUB220-07HPDT	SIN TWIST WIRE	D.GND	
	X 251	QAX0360-001Z	CRYSTAL	FOR IC251	
	X 651	QAX0413-001Z	CRYSTAL	FOR IC651	

■ Electrical parts list (CD select switch board) Block No. 05

△	Item	Parts number	Parts name	Remarks	Area
	CN804	QGB2016J1-07	CONNECTOR		
	SW 1	QSW0859-001	DETECT SWITCH		
	SW 2	QSW0859-001	DETECT SWITCH		
	SW 3	QSW0859-001	DETECT SWITCH		
	SW 4	QSW0859-001	DETECT SWITCH		
	SW 5	QSW0859-001	DETECT SWITCH		
	SW 6	QSW0859-001	DETECT SWITCH		

■ Electrical parts list
(Head amplifier&mechanism control board)

Block No. 06

Item	Parts number	Parts name	Remarks	Area
C 101	NCS21HJ-561X	C CAPACITOR		
C 102	NCS21HJ-331X	C CAPACITOR		
C 103	NCS21HJ-561X	C CAPACITOR		
C 104	NCS21HJ-221X	C CAPACITOR		
C 105	QEK40JM-227	E CAPACITOR	220MF 20% 6.3V	
C 106	NCB21HK-333X	C CAPACITOR		
C 107	QEK41EM-475	E CAPACITOR	4.7MF 20% 25V	
C 108	NCB21HK-393X	C CAPACITOR		
C 110	NCS21HJ-221X	C CAPACITOR		
C 111	QEK41HM-104	E CAPACITOR	10MF 20% 50V	
C 112	QEK41CM-106	E CAPACITOR	10MF 20% 16V	
C 113	NCB21HK-332X	C CAPACITOR		
C 114	QEK41EM-475	E CAPACITOR	4.7MF 20% 25V	
C 115	NCB21HK-153X	C CAPACITOR		
C 116	NCB21HK-822X	C CAPACITOR		
C 117	NCB21HK-223X	C CAPACITOR		
C 119	NCB21HK-563X	C CAPACITOR		
C 120	NCS21HJ-330X	C CAPACITOR		
C 201	NCS21HJ-561X	C CAPACITOR		
C 202	NCS21HJ-331X	C CAPACITOR		
C 203	NCS21HJ-561X	C CAPACITOR		
C 204	NCS21HJ-221X	C CAPACITOR		
C 205	QEK40JM-227	E CAPACITOR	220MF 20% 6.3V	
C 206	NCB21HK-333X	C CAPACITOR		
C 207	QEK41EM-475	E CAPACITOR	4.7MF 20% 25V	
C 208	NCB21HK-393X	C CAPACITOR		
C 210	NCS21HJ-221X	C CAPACITOR		
C 211	QEK41HM-104	E CAPACITOR	10MF 20% 50V	
C 212	QEK41CM-106	E CAPACITOR	10MF 20% 16V	
C 213	NCB21HK-332X	C CAPACITOR		
C 214	QEK41EM-475	E CAPACITOR	4.7MF 20% 25V	
C 215	NCB21HK-153X	C CAPACITOR		
C 216	NCB21HK-822X	C CAPACITOR		
C 217	NCB21HK-223X	C CAPACITOR		
C 219	NCB21HK-563X	C CAPACITOR		
C 220	NCS21HJ-330X	C CAPACITOR		
C 301	QEK41CM-106	E CAPACITOR	10MF 20% 16V	
C 302	QEK41CM-476	E CAPACITOR	47MF 20% 16V	
C 303	QEK41CM-226	E CAPACITOR	22MF 20% 16V	
C 304	QEK41EM-475	E CAPACITOR	4.7MF 20% 25V	
C 305	NCB21HK-393X	C CAPACITOR		
C 306	QEK40JM-227	E CAPACITOR	220MF 20% 6.3V	
C 308	NCB21HK-562X	C CAPACITOR		
C 309	NCB21HK-562X	C CAPACITOR		
C 310	NCB21HK-223X	C CAPACITOR		
C 311	NCB21HK-682X	C CAPACITOR		
C 313	QEKJ1AM-107Z	E CAPACITOR	100MF 20% 10V	
C 314	QCZ0205-155Z	ML C CAPACITOR	1.5MF	
C 315	QCZ0205-155Z	ML C CAPACITOR	1.5MF	
C 316	QFG32AJ-103Z	PP CAPACITOR	010MF 5% 100V	
C 318	NCB21HK-103X	C CAPACITOR		
C 319	QFG32AJ-821Z	TF CAPACITOR	820PF 5% 100V	
C 321	NCB21HK-103X	C CAPACITOR		
C 322	QFG32AJ-152Z	M CAPACITOR	1500PF 5% 100V	
C 327	QEK41CM-476	E CAPACITOR	47MF 20% 16V	
C 328	NCS21HJ-151X	C CAPACITOR		
C 329	NCS21HJ-151X	C CAPACITOR		
C 330	NCS21HJ-151X	C CAPACITOR		
C 332	NCS21HJ-151X	C CAPACITOR		
C 335	NCB21HK-103X	C CAPACITOR		
C 336	NCB21HK-103X	C CAPACITOR		
C 337	NCB21HK-103X	C CAPACITOR		
C 338	NCB21HK-103X	C CAPACITOR		

Item	Parts number	Parts name	Remarks	Area
C 339	QEK41CM-476	E CAPACITOR	47MF 20% 16V	
C 340	NCB21HK-103X	C CAPACITOR		
C 341	QEKJ1AM-107Z	E CAPACITOR	100MF 20% 10V	
C 342	QEK41EM-475	E CAPACITOR	4.7MF 20% 25V	
C 343	QET41CM-106	E CAPACITOR	10MF 20% 16V	
C 344	NCB21HK-472X	C CAPACITOR		
C 345	NCS21HJ-331X	C CAPACITOR		
C 350	QFLM1HJ-102Z	M CAPACITOR	1000PF 5% 50V	
CN301	QGF1205F1-06	CONNECTOR		
CN302	QGF1205F1-06	CONNECTOR		
CN303	QGB2011M1-10	B TO B CONNECTOR		
CN304	QGB2011M1-10	B TO B CONNECTOR		
CN305	QGF1205F1-10	CONNECTOR		
CN306	QGF1205F1-11	CONNECTOR		
D 307	HZM5.1NB2-X	CHIP Z DIODE CM		
D 308	HZM5.1NB2-X	CHIP Z DIODE CM		
D 309	MA704A-X	S.K.DIODE		
IC301	BA3126N	IC		
IC302	AN7345K	IC		
IC303	BU4094BCF-X	IC		
IC304	BU4094BCF-X	IC		
L 202	QQR0779-001Z	INDUCTOR	EMC	
L 301	QQR0620-001	OSC COIL(BIAS)		
L 303	QQL01BK-100Z	INDUCTOR		
Q 102	DTC144TKA-X	TRANSISTOR		
Q 103	DTC144EKA-X	TRANSISTOR		
Q 105	2SC3576-JVC-T	TRANSISTOR		
Q 202	DTC144TKA-X	TRANSISTOR		
Q 203	DTC144EKA-X	TRANSISTOR		
Q 205	2SC3576-JVC-T	TRANSISTOR		
Q 302	2SC2001/K-T	TRANSISTOR		
Q 303	2SC2001/K-T	TRANSISTOR		
Q 304	2SC3576-JVC-T	TRANSISTOR		
Q 305	2SC3576-JVC-T	TRANSISTOR		
Q 306	2SC2412K/RS-X	CHIP TRANSISTOR		
Q 307	2SC2412K/RS-X	CHIP TRANSISTOR		
Q 308	2SC2412K/RS-X	CHIP TRANSISTOR		
Q 309	2SC2412K/RS-X	CHIP TRANSISTOR		
Q 312	2SB562/C-T	TRANSISTOR		
Q 313	2SC2412K/RS-X	CHIP TRANSISTOR		
Q 314	2SB562/C-T	TRANSISTOR		
Q 315	2SC2412K/RS-X	CHIP TRANSISTOR		
Q 316	2SA952/LK-T	TRANSISTOR		
Q 317	DTC124EKA-X	TRANSISTOR		
Q 321	DTC144EKA-X	TRANSISTOR		
Q 322	DTC144EKA-X	TRANSISTOR		
Q 323	2SC2412K/RS-X	CHIP TRANSISTOR		
R 102	NRSA02J-102X	MG RESISTOR		
R 103	NRSA02J-183X	MG RESISTOR		
R 105	NRSA02J-220X	MG RESISTOR		
R 106	NRSA02J-392X	MG RESISTOR		
R 107	NRSA02J-123X	MG RESISTOR		
R 108	NRSA02J-222X	MG RESISTOR		
R 109	NRSA02J-152X	MG RESISTOR		
R 111	NRSA02J-562X	MG RESISTOR		
R 112	NRSA02J-122X	MG RESISTOR		
R 113	NRSA02J-271X	MG RESISTOR		
R 114	NRSA02J-391X	MG RESISTOR		
R 115	NRSA02J-332X	MG RESISTOR		
R 117	NRSA02J-332X	MG RESISTOR		
R 118	NRSA02J-152X	MG RESISTOR		
R 119	NRSA02J-203X	MG RESISTOR		
R 120	NRSA02J-102X	MG RESISTOR		

MX-J550R
MX-J552R

■ **Electrical parts list**
(Head amplifier&mechanism control board)

Block No. 06

△	Item	Parts number	Parts name	Remarks	Area
	R 121	NRSA02J-122X	MG RESISTOR		
	R 202	NRSA02J-102X	MG RESISTOR		
	R 203	NRSA02J-183X	MG RESISTOR		
	R 205	NRSA02J-220X	MG RESISTOR		
	R 206	NRSA02J-392X	MG RESISTOR		
	R 207	NRSA02J-123X	MG RESISTOR		
	R 208	NRSA02J-222X	MG RESISTOR		
	R 209	NRSA02J-152X	MG RESISTOR		
	R 211	NRSA02J-562X	MG RESISTOR		
	R 212	NRSA02J-122X	MG RESISTOR		
	R 213	NRSA02J-271X	MG RESISTOR		
	R 214	NRSA02J-391X	MG RESISTOR		
	R 215	NRSA02J-332X	MG RESISTOR		
	R 217	NRSA02J-332X	MG RESISTOR		
	R 218	NRSA02J-152X	MG RESISTOR		
	R 219	NRSA02J-203X	MG RESISTOR		
	R 220	NRSA02J-102X	MG RESISTOR		
	R 221	NRSA02J-122X	MG RESISTOR		
	R 301	NRS181J-221X	MG RESISTOR		
	R 302	NRS181J-101X	MG RESISTOR		
	R 304	NRSA02J-393X	MG RESISTOR		
	R 305	NRSA02J-103X	MG RESISTOR		
	R 306	NRSA02J-103X	MG RESISTOR		
	R 307	NRSA02J-103X	MG RESISTOR		
	R 308	NRSA02J-152X	MG RESISTOR		
	R 309	NRSA02J-152X	MG RESISTOR		
	R 310	NRS181J-820X	MG RESISTOR		
	R 311	NRS181J-820X	MG RESISTOR		
	R 313	NRSA02J-3R3X	MG RESISTOR		
	R 314	NRSA02J-223X	MG RESISTOR		
	R 315	NRSA02J-100X	MG RESISTOR		
	R 316	NRSA02J-223X	MG RESISTOR		
	R 317	NRSA02J-100X	MG RESISTOR		
	R 318	NRSA02J-123X	MG RESISTOR		
	R 319	NRSA02J-152X	MG RESISTOR		
	R 321	NRSA02J-123X	MG RESISTOR		
	R 322	NRSA02J-152X	MG RESISTOR		
	R 327	NRSA02J-474X	MG RESISTOR		
	R 328	NRSA02J-222X	MG RESISTOR		
	R 329	NRSA02J-222X	MG RESISTOR		
	R 330	NRSA02J-0R0X	MG RESISTOR		
	R 335	NRSA02J-222X	MG RESISTOR		
	R 336	NRSA02J-392X	MG RESISTOR		
	R 338	NRSA02J-222X	MG RESISTOR		
	R 339	NRSA02J-222X	MG RESISTOR		
	R 341	NRSA02J-222X	MG RESISTOR		
	R 343	NRSA02J-0R0X	MG RESISTOR		
	R 345	NRSA02J-222X	MG RESISTOR		
	R 346	NRSA02J-0R0X	MG RESISTOR		
	R 347	NRSA02J-392X	MG RESISTOR		
	R 348	NRSA02J-222X	MG RESISTOR		
	R 350	NRSA02J-472X	MG RESISTOR		
	R 351	NRSA02J-151X	MG RESISTOR		
	R 353	NRSA02J-472X	MG RESISTOR		
	R 354	NRSA02J-151X	MG RESISTOR		
	R 355	NRSA02J-332X	MG RESISTOR		
	R 357	NRSA02J-103X	MG RESISTOR		
	R 358	NRSA02J-222X	MG RESISTOR		
	R 359	NRSA02J-123X	MG RESISTOR		
	R 360	NRSA02J-433X	MG RESISTOR		
	R 361	NRSA02J-183X	MG RESISTOR		
	R 362	NRSA02J-123X	MG RESISTOR		
	R 363	NRSA02J-183X	MG RESISTOR		

△	Item	Parts number	Parts name	Remarks	Area
	R 364	NRSA02J-433X	MG RESISTOR		
	R 365	NRSA02J-203X	MG RESISTOR		
	R 366	NRSA02J-123X	MG RESISTOR		
	R 367	NRSA02J-102X	MG RESISTOR		
	R 368	NRSA02J-391X	MG RESISTOR		
	R 369	NRSA02J-391X	MG RESISTOR		
	R 371	NRS181J-222X	MG RESISTOR		
	R 374	NRSA02J-912X	MG RESISTOR		
	R 375	NRSA02J-683X	MG RESISTOR		
	R 376	NRS181J-6R8X	MG RESISTOR		
	VR101	QVP0008-503Z	SEMI V RESISTOR		
	VR201	QVP0008-503Z	SEMI V RESISTOR		
	VR301	QVP0008-103Z	SEMI V RESISTOR		
	WIRE	EW34D-10CS	FLAT WIRE		

■ **Electrical parts list (Cassette switch board)**

Block No. 07

△	Item	Parts number	Parts name	Remarks	Area
	CN 1	QGB2011L1-10	B TO B CONNECTO		
	D 1	1SR139-400-T2	SI DIODE		
	IC 1	SG-105F3-BB,C	PHOTO SENSER		
	P 1	QNZ0104-001	POST PIN		
	SW 2	QSW0832-001	LEAF SWITCH	TAPE	
	SW 4	QSW0832-001	LEAF SWITCH	70U	
	SW 6	QSW0507-001	SWITCH		

■ **Electrical parts list (Cassette switch board)**

Block No. 08

△	Item	Parts number	Parts name	Remarks	Area
	CN 1	QGB2011L1-10	B TO B CONNECTO		
	D 1	1SR139-400-T2	SI DIODE		
	IC 1	SG-105F3-BB,C	PHOTO SENSER		
	P 1	QNZ0104-001	POST PIN		
	SW 1	QSW0832-001	LEAF SWITCH	R.REC	
	SW 2	QSW0832-001	LEAF SWITCH	TAPE	
	SW 4	QSW0832-001	LEAF SWITCH	70U	
	SW 5	QSW0832-001	LEAF SWITCH	F.REC	
	SW 6	QSW0507-001	SWITCH		

-MEMO-

MX-J550R
MX-J552R

Packing materials and accessories parts list

CA-MXJ550R/CA-MXJ552R

SP-MXJ500/SP-MXJ550/SP-MXJ552R

Block No.

M	5	M	M
---	---	---	---

Block No.

M	6	M	M
---	---	---	---

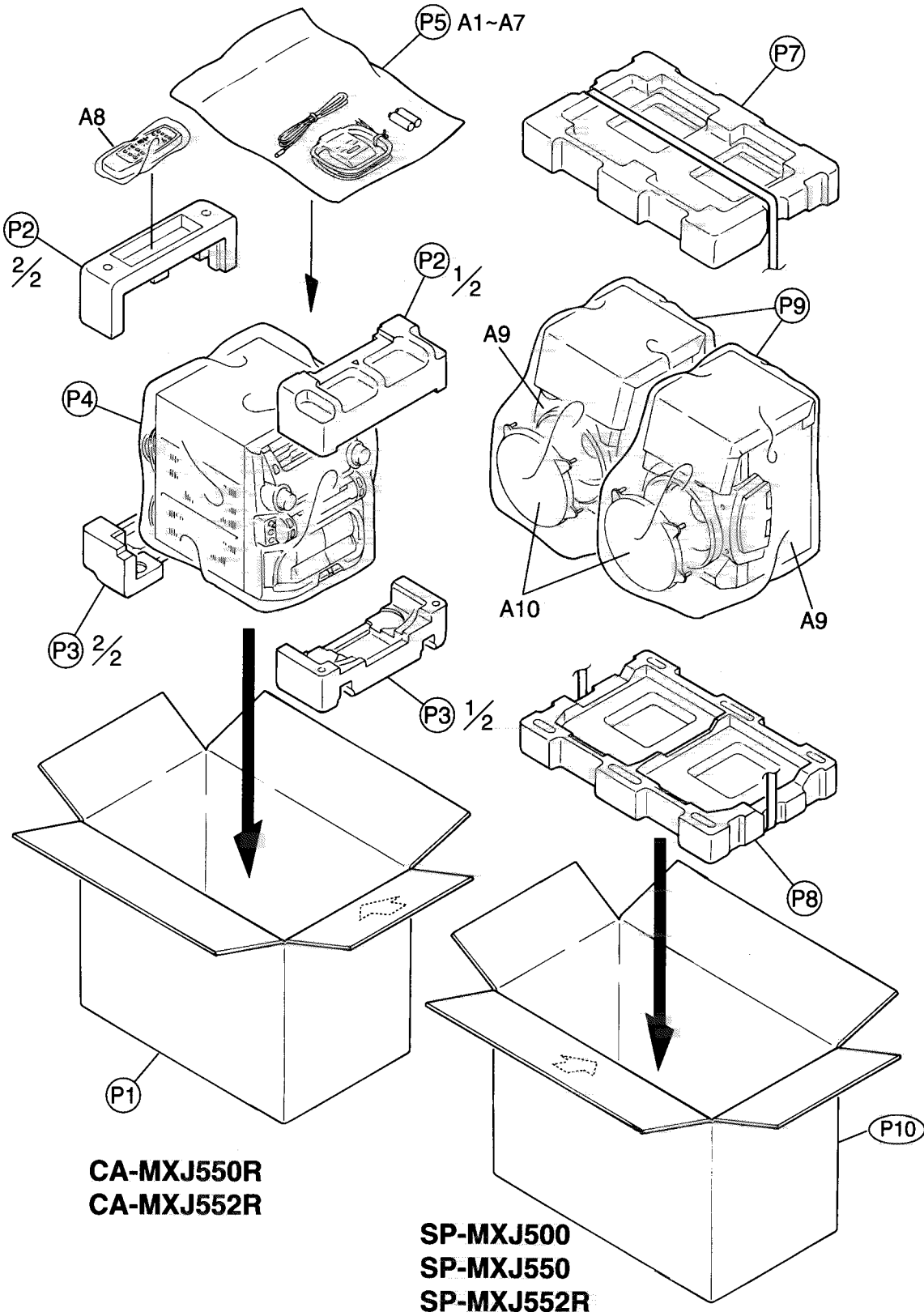

■ **Packing parts list**

Block No. **M 5 M M**

	Item	Parts Number	Parts Name	Q'ty	Description	Area
	P 1	GV10040-002A	PACKING CASE	1	CA-MXJ550R	
		GV10040-003A	PACKING CASE	1	CA-MXJ552R	
	P 2	GV10034-001A	UPPER CUSHION	1		
	P 3	GV10035-001A	BOTTOM CUSHION	1		
	P 4	QPC06507015P	POLY BAG	1		
	P 5	QPC02503515P	POLY BAG	1		
	P 7	139765141044	TOP CUSHION	1	FOR SPEAKER	
	P 8	139765141045	BOTTOM CUSHION	1	FOR SPEAKER	
	P 9	138736001066	POLY BAG	2	FOR SPEAKER	
	P 10	140773681185	PACKING CASE	1	SP-MXJ500	
		140773681186	PACKING CASE	1	SP-MXJ550	
		140773681187	PACKING CASE	1	SP-MXJ552R	

■ **Accessories parts list**

Block No. **M 6 M M**

	Item	Parts Number	Parts Name	Q'ty	Description	Area
	A 1	GVT0029-006A	INSTRUCTION BOOK	1	ENG.GER.FRE.DUT.SPA.ITA	E
		GVT0029-007A	INSTRUCTION BOOK	1	GER.FRE.DUT.SWE.DAN.FIN	EN
		GVT0029-008A	INSTRUCTION BOOK	1	ENG	B
		GVT0029-009A	INSTRUCTION BOOK	1	ENG.HUN.POL.CZE	EV
	A 2	BT-54013-1	WARRANTY CARD	1		
	A 3	VNA3000-202	REGISTER CARD	1		B
	A 5	QAL0014-001	LOOP ANTENNA	1		
	A 6	EWP503-001	ANTENNA WIRE	1		
	A 7	-----	BATTERY	1		
	A 8	RM-SMXJ550R	WIRE-LESS REMOTE CONTROL	1		
	A 9	MXJ500K-SPBOX-L	SPEAKER BOX ASS'Y(L)	1	SP-MXJ500(2WAY)	
		MXJ500K-SPBOX-R	SPEAKER BOX ASS'Y(R)	1	SP-MXJ500(2WAY)	
		MXJ550K-SPBOX-L	SPEAKER BOX ASS'Y(L)	1	SP-MXJ550(3WAY)	
		MXJ550K-SPBOX-R	SPEAKER BOX ASS'Y(R)	1	SP-MXJ550(3WAY)	
		MXJ552RK-SPBOXL	SPEAKER BOX ASS'Y(L)	1	SP-MXJ552R(3WAY)	
		MXJ552RK-SPBOXR	SPEAKER BOX ASS'Y(R)	1	SP-MXJ552R(3WAY)	
	A 10	199732080098	SPEAKER NET(L)	1	SP-MXJ500/MXJ550	
		199732080101	SPEAKER NET(R)	1	SP-MXJ500/MXJ550	
		199732080106	SPEAKER NET(L)	1	SP-MXJ552R	
		199732080107	SPEAKER NET(R)	1	SP-MXJ552R	

MX-J550R
MX-J552R

JVC

VICTOR COMPANY OF JAPAN, LIMITED
AUDIO DIVISION, 10-1, 1Chome, Ohwatari-machi, Maebashi-city, 371-8543, Japan